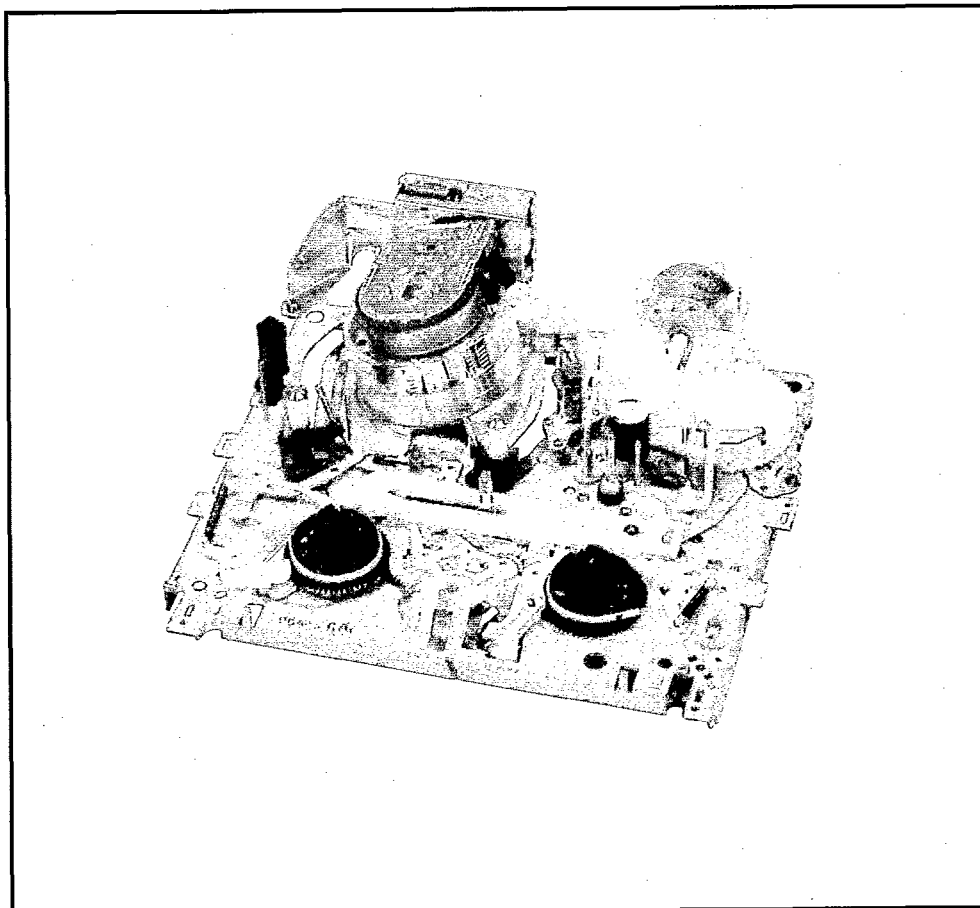

Service Manual

Video Cassette Recorder

Panasonic **VHS**

Z-MECHANISM CHASSIS

REV-1

INTRODUCTION

The Z-Mechanism chassis are built in several Panasonic VHS Video Cassette Recorders from NV-SD and NV-HD series in 1998.

⚠ WARNING

This service information is designed for experienced repair technicians only and is not designed for use by the general public. It does not contain warnings or cautions to advise non-technical individuals of potential dangers in attempting to service a product. Products powered by electricity should be serviced or repaired only by experienced professional technicians. Any attempt to service or repair the product or products dealt with in this service information by anyone else could result in serious injury or death.

Panasonic

© 1998 Matsushita Electric Industrial Co., Ltd.
All rights reserved. Unauthorized copying and distribution is a violation of law.

CONTENTS

1.	OUTLINE OF Z MECHANISM	1
1-1.	The tape transport path	1
1-2.	Cassette holder unit	2
1-3.	Reel brake	2
1-4.	Number of Gear Phase Alignment Point and Replacement Parts	3
	Z Mechanism Components	4
	FLOW CHART OF LOADING MECHANISM	5
2.	REMOVAL OF CASSETTE TAPE	6
2-1.	Removal of compulsory loading	6
2-2.	Removal of manual operation of Main cam gear	6
3.	REMOVAL OF CASSETTE HOLDER UNIT & MECHANISM CHASSIS	7
3-1.	Removal of Cassette holder unit	7
3-2.	Removal of Mechanism chassis	8
4.	DISASSEMBLY/ASSEMBLY METHOD FOR MECHANISM	9
4-1.	Disassembly of mechanism	9
4-2.	Assembly and phase adjustment of mechanism	14
4-3.	Assembly of mechanism chassis	20
	Parts Access Flow Chart	23
5.	MECHANICAL ADJUSTMENT PROCEDURES	24
5-1.	Tension post position adjustment	24
5-2.	Back tension adjustment	24
5-3.	P2 and P3 posts adjustment	25
5-4.	Tape interchangeability adjustment	25
	5-4-(1). P2 AND P3 POSTS ADJUSTMENT	26
	5-4-(2). ADJUSTMENT OF P4 POST	27
	5-4-(3). HEIGHT ADJUSTMENT OF A/C HEAD	28
	5-4-(4). FINE-ADJUSTMENT OF A/C HEAD	28
	5-4-(5). ADJUSTMENT OF X-VALUE	28
	5-4-(6). FINE-ADJUSTMENT OF X-VALUE	29
	Servicing Fixtures & Tools	30
6.	SELF-TEST INDICATION DISPLAY	31
7.	SERVICE INFORMATION DISPLAY	33
7-1.	Purpose of Service Information Display	33
7-2.	Turning on Service Information Display	33
7-3.	Use of Service Modes	34
7-4.	Service Information Number	36
7-5.	Test Mode	36
7-6.	Timing chart from Mode SW to System control IC	38
8.	SYSTEM CONTROL CIRCUIT & MECHANISM CONTROL CIRCUIT	39
8-1.	STOP 3 Specification	39
8-2.	Stand-by in the STOP3 position	39
8-3.	Supply and Take-up Sensors	40
8-4.	Safety Tab Switch	40
8-5.	Dew Sensor	41
8-6.	Setting time for each mode	42
8-7.	Operation of short CUE	42
8-8.	Loading/Unloading Mechanism lock	42
8-9.	Cassette loading/unloading lock	42
8-10.	Reel lock operation	43
8-11.	Cylinder lock	43
8-12.	Mode transition	44
8-13.	Power on reset	44
8-14.	Linear time counter operation	44
8-15.	Tape speed in CUE/REV mode	45
8-16.	Automatic functions	45
8-17.	CUE/REV lock mode	45
8-18.	FR (Forward/Reverse) search mode	45
8-19.	FF/REW speed	45
8-20.	FF/REW time	45
9.	EXPLODED VIEWS & REPLACEMENT PARTS LIST	
9-1.	MECHANICAL REPLACEMENT PARTS SECTION	

1. OUTLINE OF Z MECHANISM

1-1. The tape transport path

(1) Mechanism Chassis

Aluminium Chassis has been changed to sheet metal (Thickness: 1.2 mm).

(2) Capstan position (Cassette-in method/Capstan-in method)

The Tape does not touch the Cassette tape so that the rationalization has been promoted such as Reel gear pinch up/down mechanism has been deleted.

(3) Deletion of P1 post

FE Head has been installed Limiter so that P1 post has been deleted.

(4) A/C Head base combined with P4 post

A/C Head has been combined with P4 post on the same base.

(5) Change of A/C head base type

The change of the angle winding the tape on A/C head has been reduced by the construction of A/C head base has been changed from the revolution type to slide base type.

(6) Improvement of P5 post

P5 post operation has been changed by non-adjustable of the Height and the Tilt adjustment so that the specification has been improved.

Z Mechanism tape transport path in REV mode

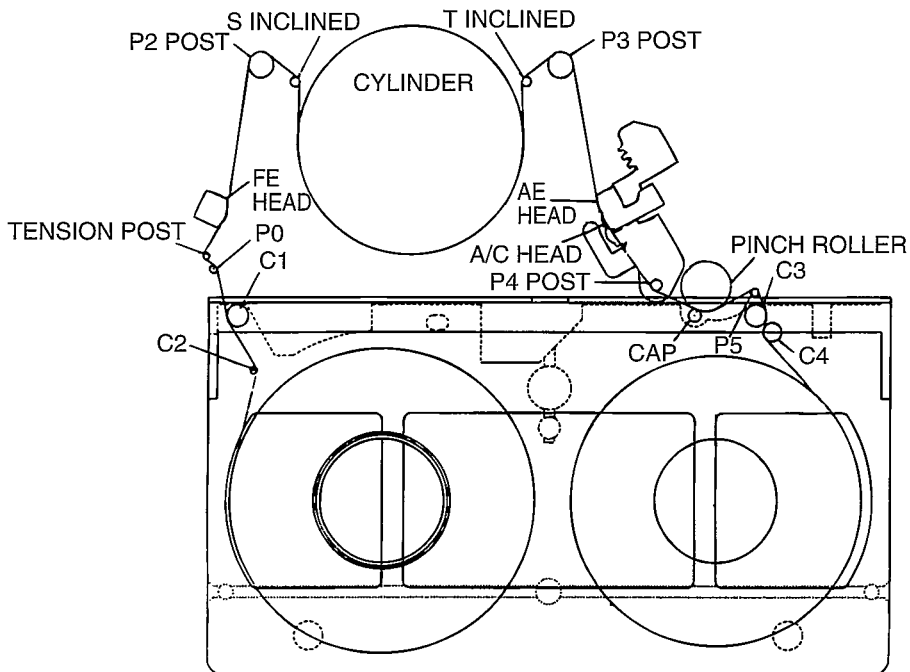

1-2. Cassette holder unit

(1) Cassette-in operation

The Rack drive arm drives Main Cam gear by inserting the cassette tape. Consequently, Position switch detects the cassette-in mode so that Loading motor drives. The mode goes to the Stop mode from the Cassette-in through the Loading mode.

① The parts quantity reduction of Cassette holder unit.

(Z Mechanism: 21 pieces, K Mechanism: 36 pieces)

- a. Release lever has been installed in Right Side Plate.
- b. Cassette guide has been installed in Front Panel unit.
- c. Safety lever spring is made by the resin.
- d. Opener lever has been changed into the single opener type.
- e. One side of Side Plate unit is hung on Chassis in order to fix it.

② Improvement of the cassette insertion

(The force of the cassette insertion Z Mechanism: Approximately 400gm.,

K Mechanism: Approximately 600gm.)

The tooth pitch of Worm gear which has been extended against the previous model, is located on the Motor so that Worm gear can be reversed. Consequently, the Motor rotates before the insertion spring (the combined spring) is working when the cassette tape is inserted, so that the repelled force of the insertion spring has been reduced as differing from the present model.

③ Small-sized Cassette holder unit (Thinned unit)

- a. The Wiper arm method which has been adopted, assigned Wiper arm between Cassette Holder Plate and Side Plate so that the small-sized of the width has been realized.
- b. To prevent the increment of parts quantity such as Safety lever is used for Pre-open mechanism shown in the present model, and the small-sized unit has been realized by inclining one portion of the L groove in Side Plate.
- c. The part of driving change-over is located in the nearest to the center of Reel so that the depth size is compact.

1-3. Reel brake

(1) Supply Reel Brake is used for Tension Regulator which is composed of the conventional Main brake and the soft brake function.

(2) Take-up Reel Brake is used as Band Brake unit in order to correspond with Supply Reel Brake.

※ Tension Regulator performance:

This is composed of Tension regulator and brake. The tape always is given the tension against the advance direction by Tension band.

(3) Construction of Supply reel tension regulator

Comparison of the construction with the conventional model

	Z Mechanism	K Mechanism
Tension Arm Shaft Bearing construction	Resin	Tension arm
Tension Band	Felt less Lumiller	Felt Lumiller
Braking method	Tension regulator	Main & soft brake

Operating mode and necessary function

Mechanism mode	Necessary function	Operation
Cassette down	Prevention of the tape slag (Soft brake)	Soft brake
Completion of Loading	Prevention of the tape slag (Soft brake)	Tension regulator
REV	Prevention of in Play mode to REV mode (Soft brake)	Tension regulator
PLAY, FF	Back tension adjustment	Same as the conventional
STOP	Main brake function	Tension regulator

(4) Construction of Take-up brake

Take-up brake is used Band brake as well as Supply brake depend on corresponding with Band brake is adopted at the Supply Side.

Mechanism mode	Function	Band
EJECT-MID	Soft brake	On
REV	Soft brake	On
PLAY	Release of brake	Off
STOP	Brake	On
FF/REW	Release of brake	Off

1-4. Number of Gear Phase Alignment Point and Replacement Parts

Number of Gear Phase Alignment Point	
G2 Mechanism	12 Alignment Points
G Mechanism	12 Alignment Points
K Mechanism	6 Alignment Points
Z Mechanism	4 Alignment Points
Number of Replacement Parts (including the Screw and Washer)	
G2 Mechanism	Approx. 170 Pieces
G Mechanism	Approx. 150 Pieces
K Mechanism	Approx. 100 Pieces
Z Mechanism	Approx. 70 Pieces

Z Mechanism Components

TOP VIEW

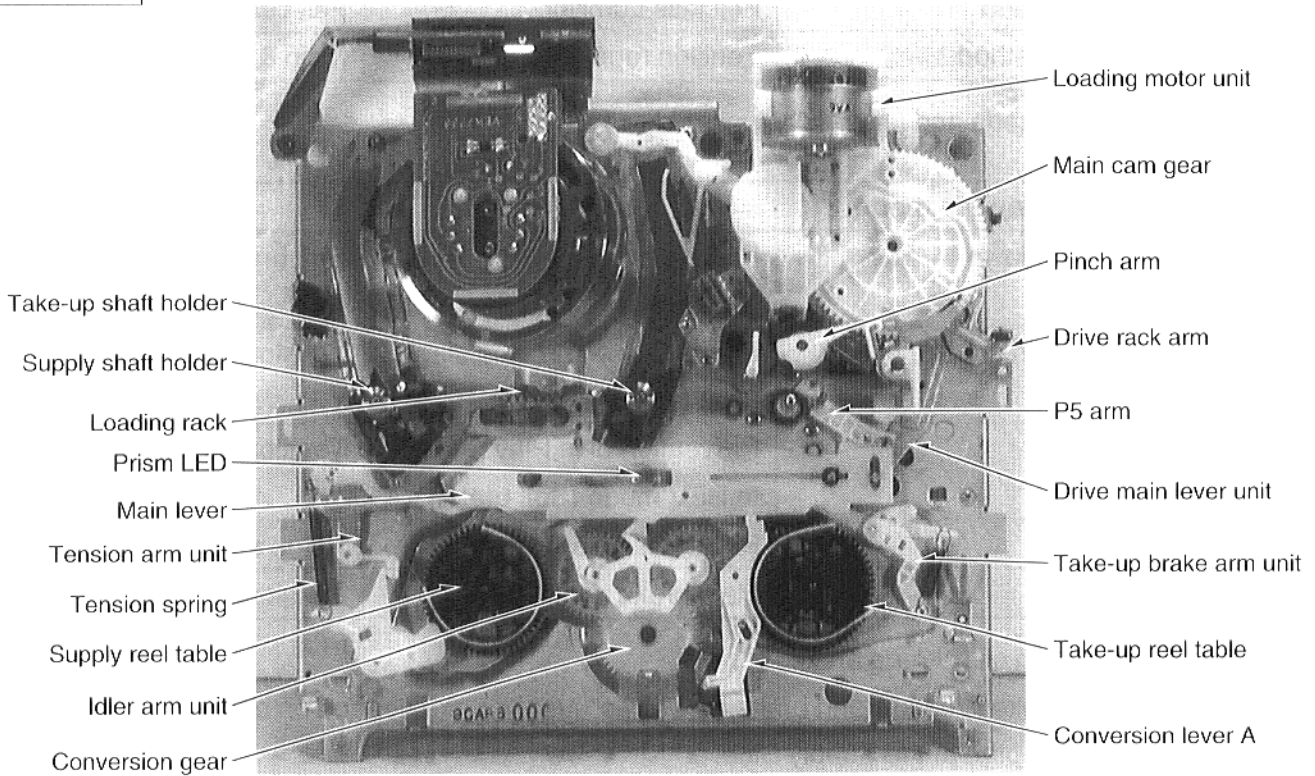

BOTTOM VIEW

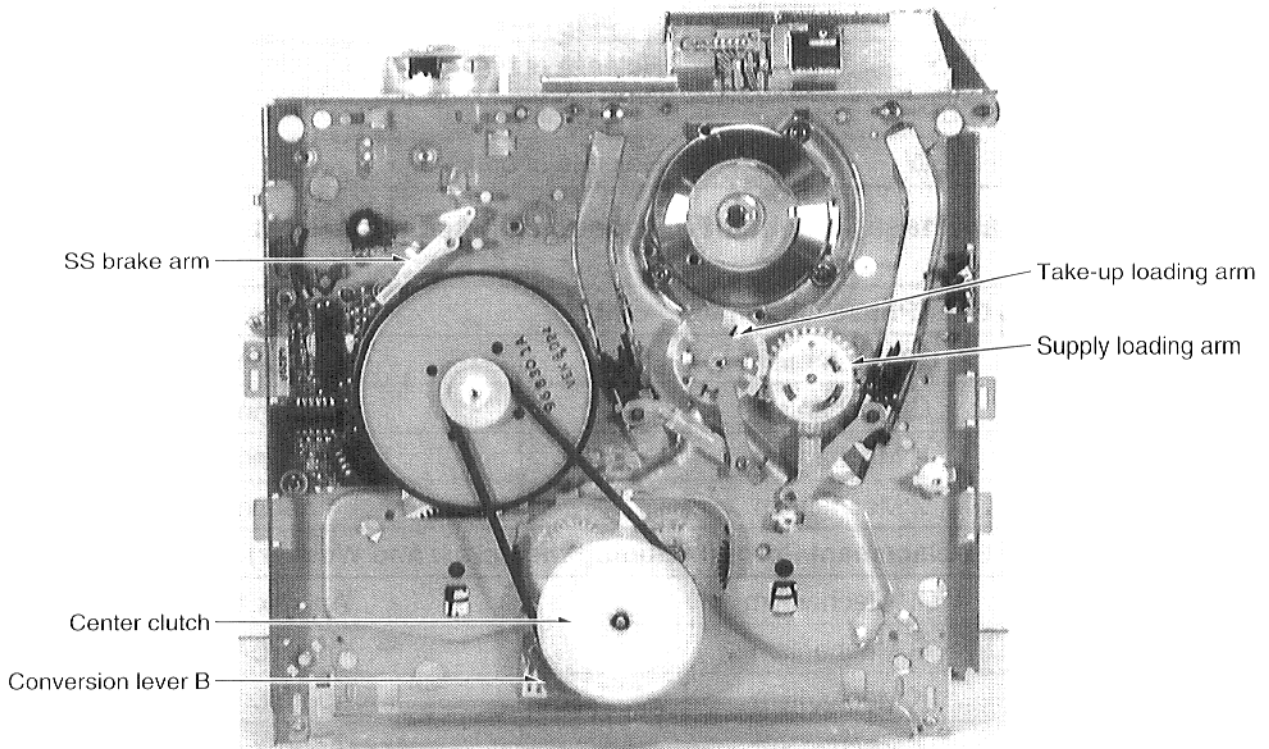

FLOW CHART OF LOADING MECHANISM

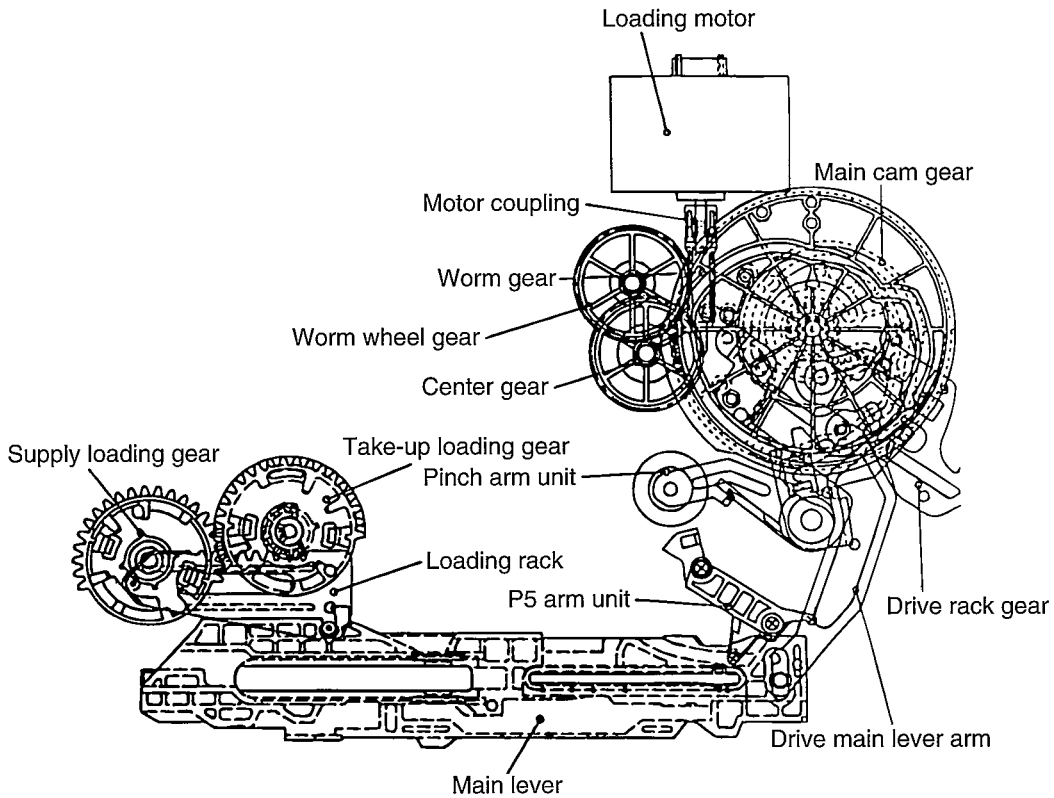
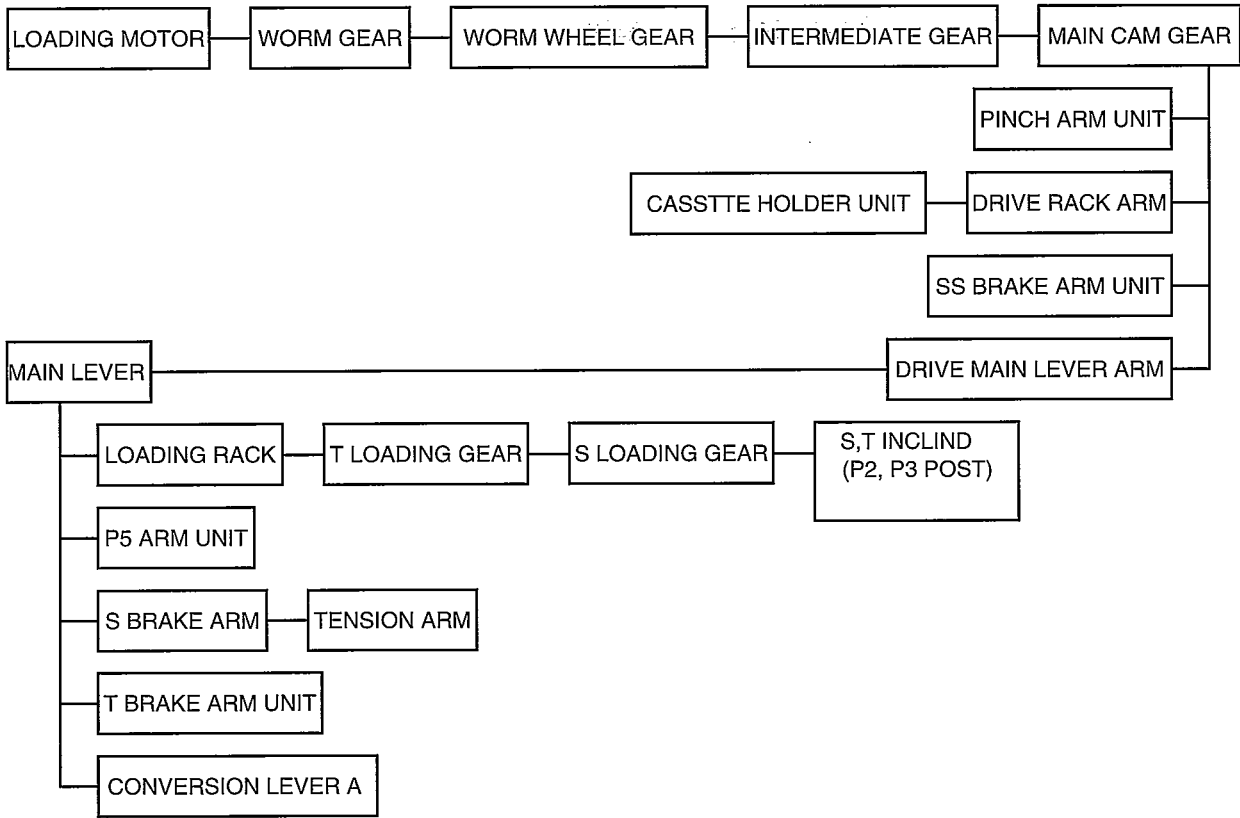

2. REMOVAL OF CASSETTE TAPE

There are 2 ways to remove a cassette tape.

2-1. Removal of compulsory loading

(1) Press FF and EJECT buttons simultaneously for more than 3 seconds and set the Service Mode 7.

In case of VCR mounted shuttle ring, turn the shuttle ring to FF and then press EJECT button for more than 3 seconds.

In Loewe model, STOP button is used instead of FF button.

(2) Press STOP button in order to unload the mechanism. (Pay an attention of tape slack)

Service Mode Indication :

7 ※ ※ ※ ※ (STOP) → 7 00 ※ ※ (EJECT)

2-2. Removal of manual operation of Main cam gear

(1) Disconnect the AC power cord and remove Top Panel.

(2) Rotate Main cam gear to the clockwise and unload the mechanism (Tape is remaining) (Fig. A1).

TOP VIEW

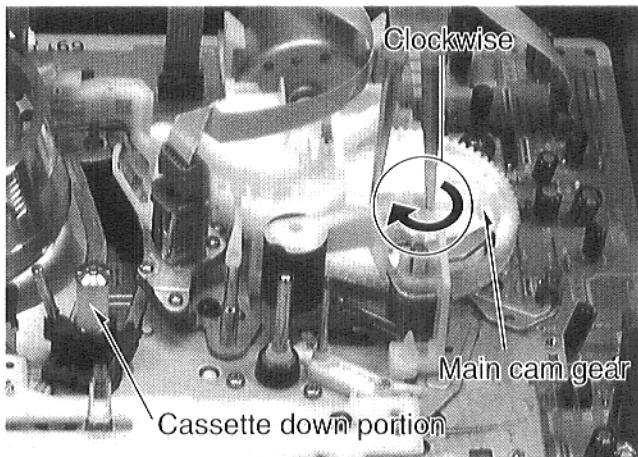

Fig. A1

(3) Rotate the Pole of Capstan motor to the clockwise from the bottom in order to remove the tape slack (Fig. A2).

BOTTOM VIEW

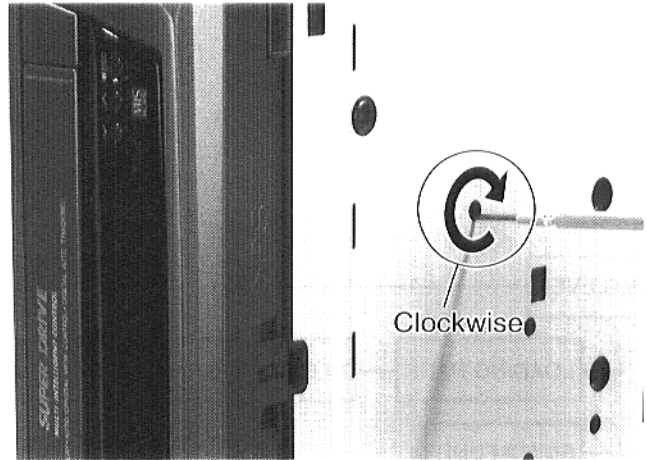

Fig. A2

(4) Rotate Main cam gear to the clockwise in order to eject the cassette tape.

3. REMOVAL OF CASSETTE HOLDER UNIT & MECHANISM CHASSIS

3-1. Removal of Cassette holder unit

(1) Remove Top panel and Front panel unit (Fig. B1).

TOP VIEW

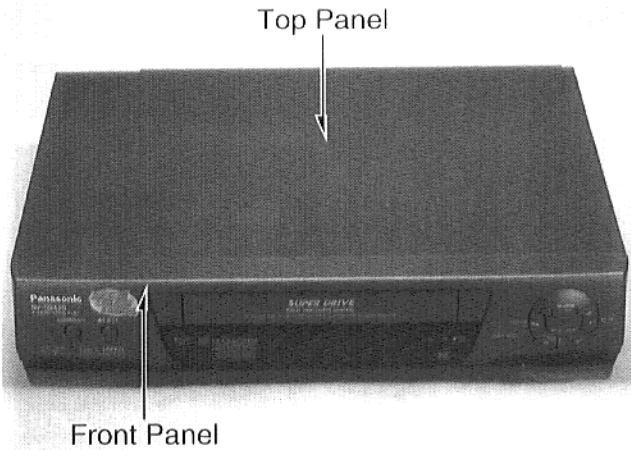

Fig. B1

(2) Remove Top plate

Remove 4 tabs fixing Top plate and remove Top plate (Fig. B2).

※ 4 Tabs should be removed softly due to they are fragile.

TOP VIEW

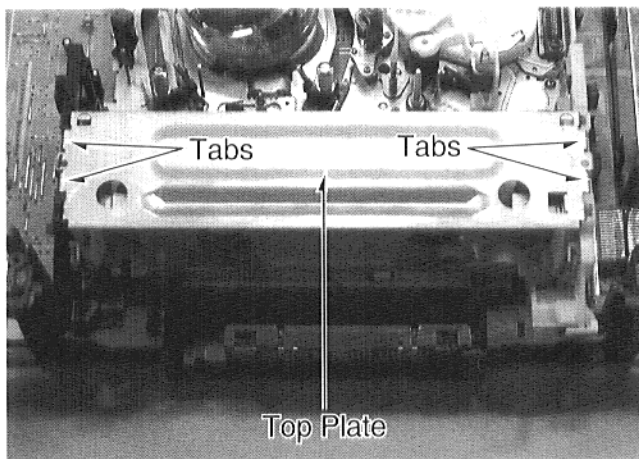

Fig. B2

(3) Remove Cassette Holder

Keep pressing 2 stoppers on Cassette holder and Press Cassette holder to the rear and remove it from Left and Right Side Plate (Fig. B3).

TOP VIEW

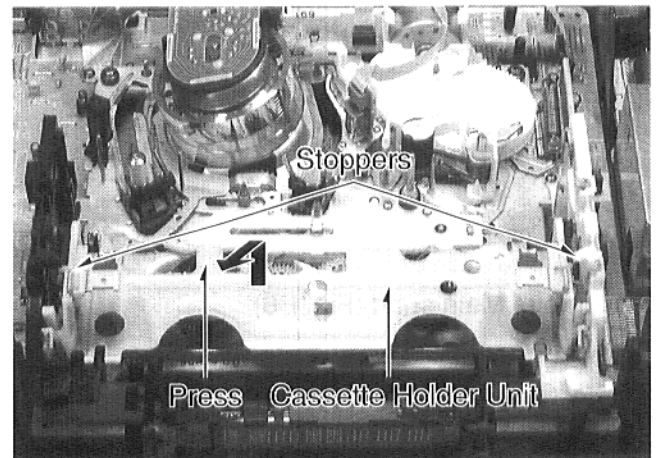

Fig. B3

(4) Remove Left and Right Side Plate

Remove connection spring of Drive gear.

Remove 3 red screws, 3 tabs and remove Left and Right Side Plate (Fig. B4, B5).

TOP VIEW

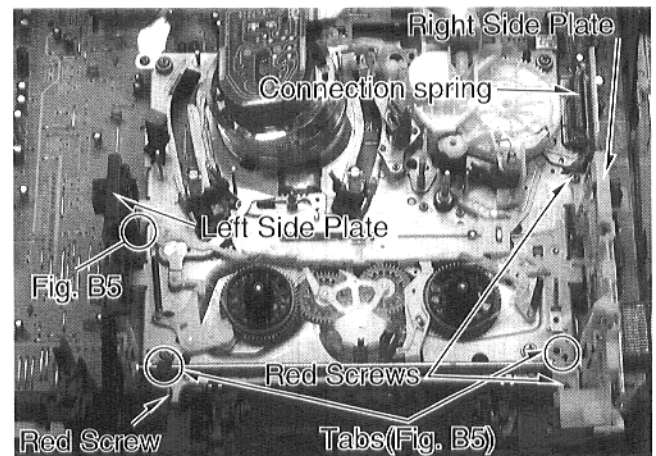

Fig. B4

TOP VIEW

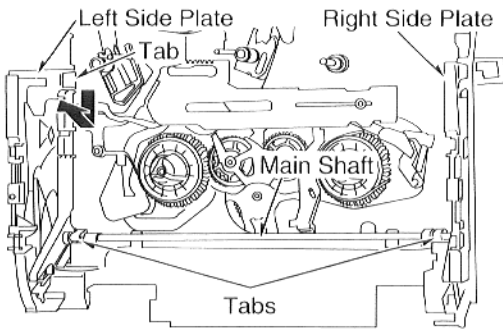

Fig. B5

(5) Remove Main shaft (Fig. B6)

TOP VIEW

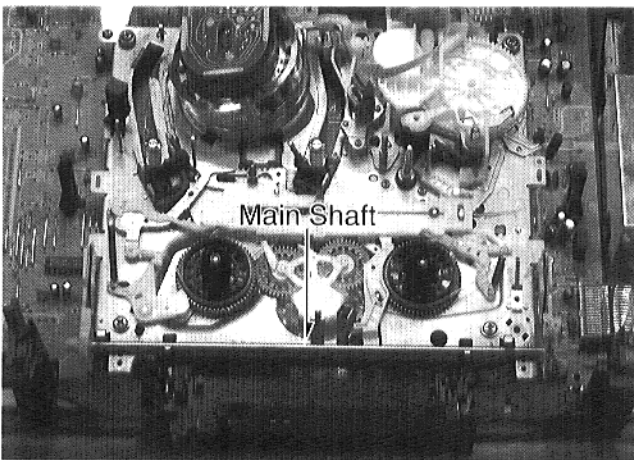

Fig. B6

3-2. Removal of Mechanism chassis

(1) Remove Mechanism chassis

Disconnect P3001, P2502 and P4002 (the connectors of Head amp C.B.A., Cylinder unit and A/C Head). Remove 5 screws (3 red screws and 2 gold screws) on Mechanism chassis and take out Mechanism chassis (Fig. B7).

TOP VIEW

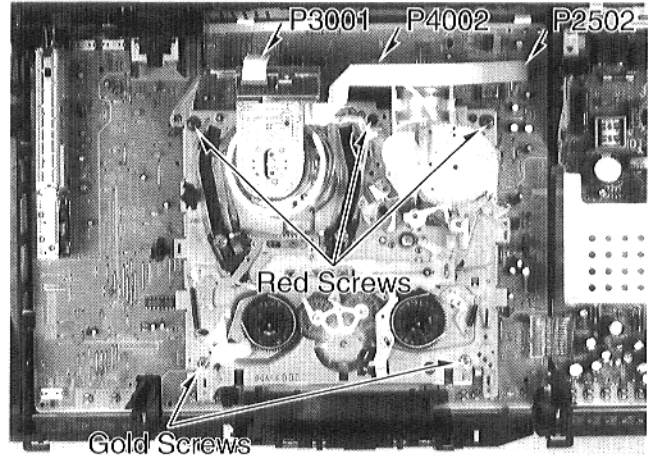

Fig. B7

4. DISASSEMBLY/ASSEMBLY METHOD FOR MECHANISM

4-1. Disassembly of mechanism

1. Removal of Pinch arm

Unlock the tab (opener piece). Remove Opener piece and Pinch arm (Fig. C1).

2. Removal of Loading motor unit

Unlock 3 tabs and remove Loading motor unit (Fig. C1, C2).

2 tabs of them located on the bottom of the Mechanism (Fig. C2).

TOP VIEW

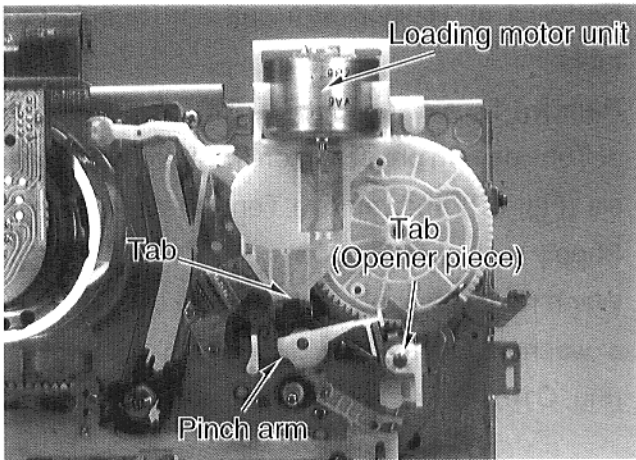

Fig. C1

BOTTOM VIEW

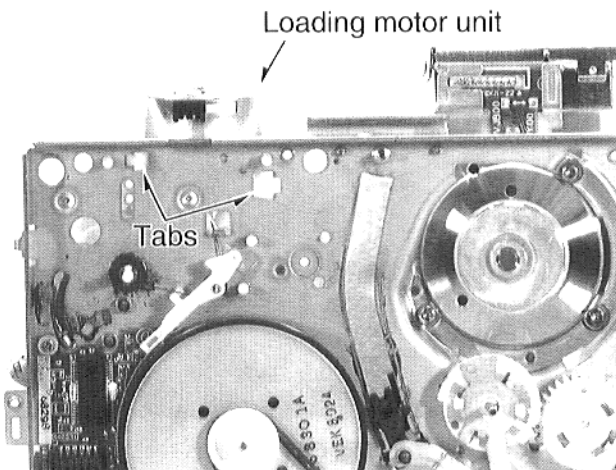

Fig. C2

3. Removal of Main cam gear

Remove Snap washer located on the bottom of Chassis by using retaining ring remover (Fig. C3) and remove Main cam gear (Fig. C4).

BOTTOM VIEW

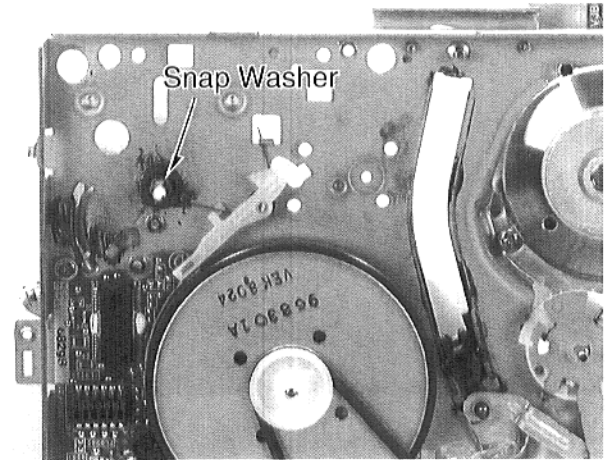

Fig. C3

TOP VIEW

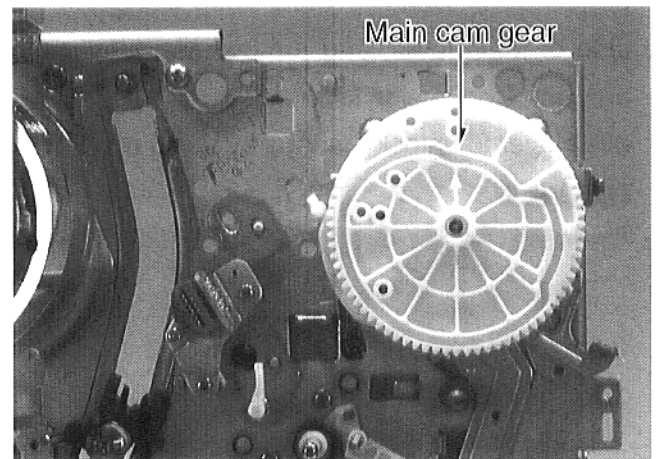

Fig. C4

4. Removal of Drive rack arm

Rotate Drive rack arm to the counterclockwise and remove it (Fig. C5).

TOP VIEW

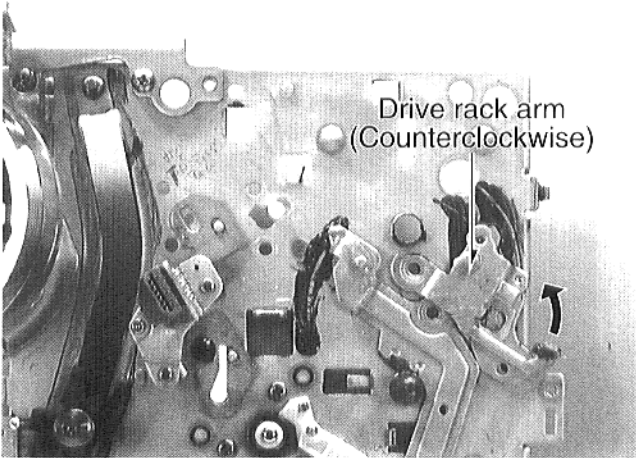

Fig. C5

5. Removal of Main lever, P5 arm and Conversion lever A

Unlock 2 tabs of Prism LED and 1 tab on the projection of Chassis while keep lifting the left side of Main lever, and remove Main lever, P5 arm and Conversion lever A (Fig. C6).

※ It is easier to unlock the tabs by using a tweezer.

TOP VIEW

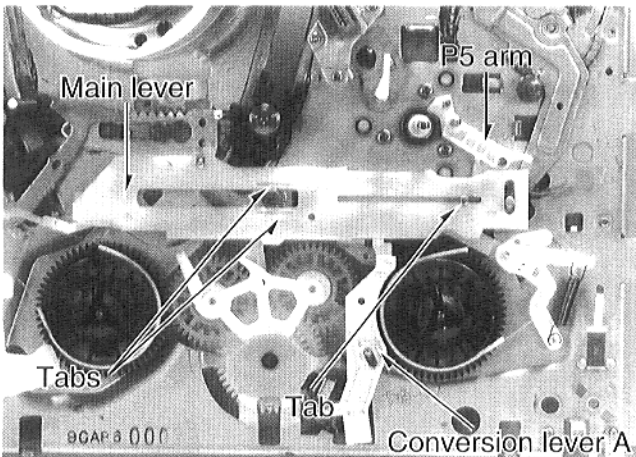

Fig. C6

6. Removal of Drive main lever arm

Rotate Drive main lever arm to the counterclockwise and remove it (Fig. C7).

TOP VIEW

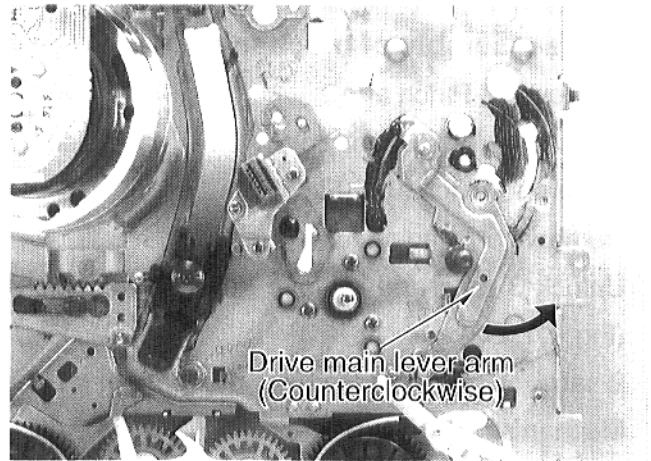

Fig. C7

7. Removal of Tension arm unit and Supply reel table

Remove Tension spring (Fig. C8). Unlock the tab of Tension arm projection on the bottom of Chassis (Fig. C9) and remove Tension arm unit and Supply reel table (Fig. C8).

※ When remove supply reel table, be sure whether a washer attaches on Supply reel table shaft (Fig. C10).

TOP VIEW



Fig. C8

BOTTOM VIEW

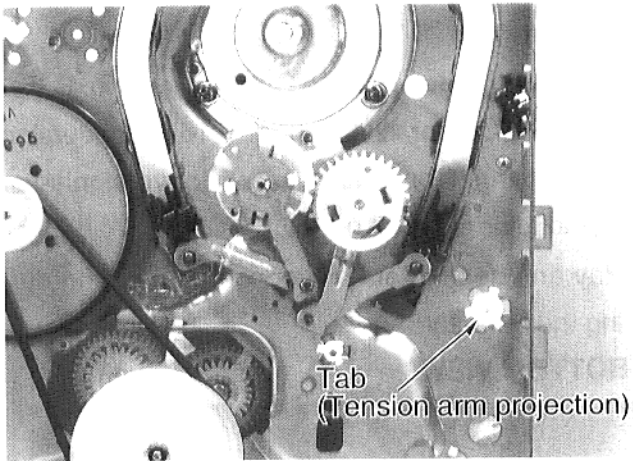

Fig. C9

TOP VIEW

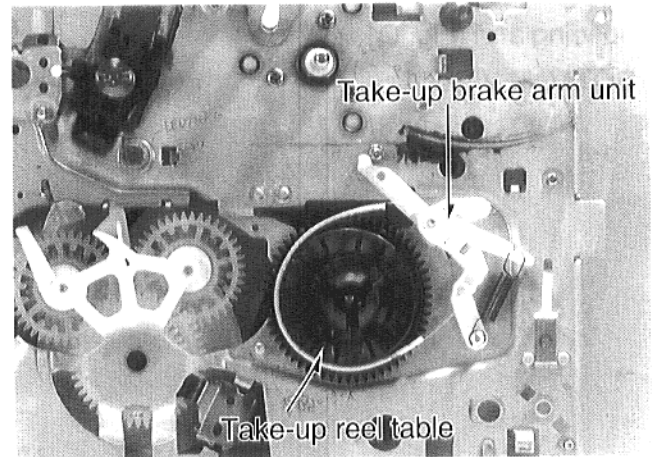

Fig. C11

SIDE VIEW

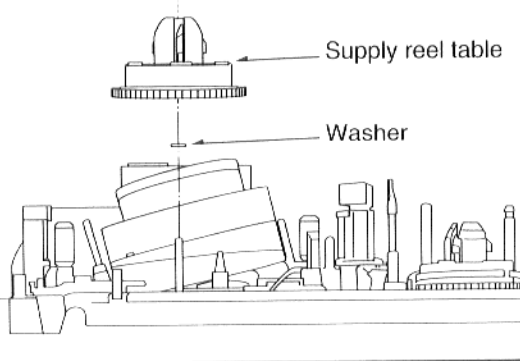

Fig. C10

8. Remove of Take-up brake arm unit and Take-up reel table

Unlock the tab of Take-up brake arm unit from the bottom of Chassis (Fig. C12). Remove Take-up brake arm unit and Take-up reel table (Fig. C11).

- ※ When remove Take-up reel table, be sure whether a washer attaches on Take-up reel table shaft (Fig. C13).

BOTTOM VIEW

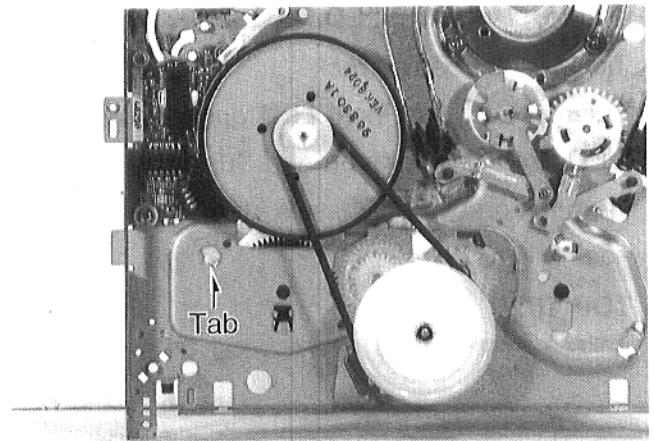

Fig. C12

SIDE VIEW

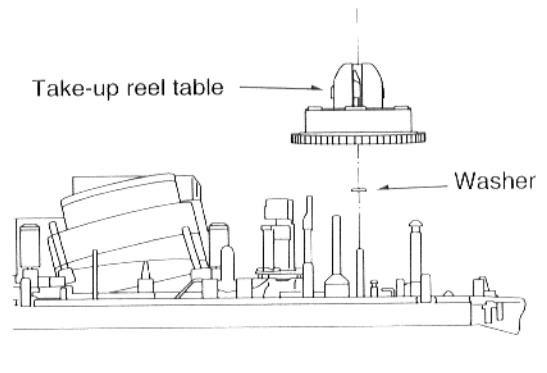

Fig. C13

9. Removal of Take-up & Supply loading arm

Unlock the tab and remove Take-up and Supply loading arm (Fig. C14).

BOTTOM VIEW

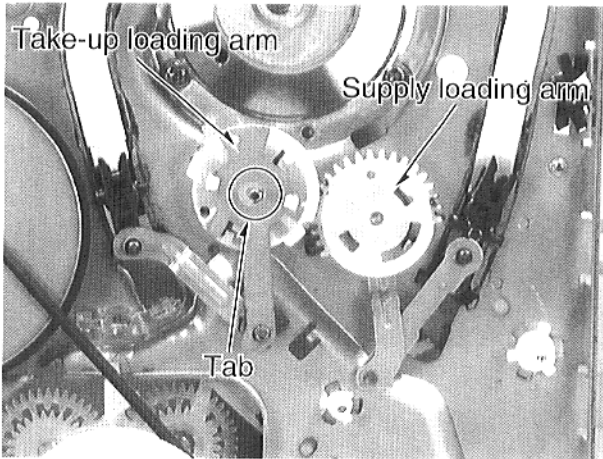

Fig. C14

10. Removal of Prism LED, Take-up & Supply shaft holder and Loading rack

Push the tab of Prism LED and remove Prism LED. Remove Take-up and Supply shaft holder from the groove of Chassis and remove Loading rack (Fig. C15).

TOP VIEW

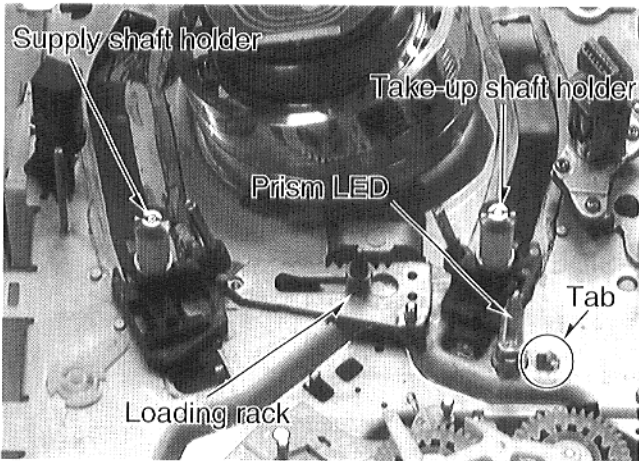

Fig. C15

11. Removal of Center clutch, Conversion gear spring, Conversion gear, Conversion lever B and Idler arm unit

Remove the Belt and the Cut washer (Fig. C16). Remove Center clutch (Fig. C16), Conversion gear spring, Conversion gear, Conversion lever B and Idler arm unit (Fig. C17).

※ Pay an attention of Conversion gear spring during the removal.

BOTTOM VIEW

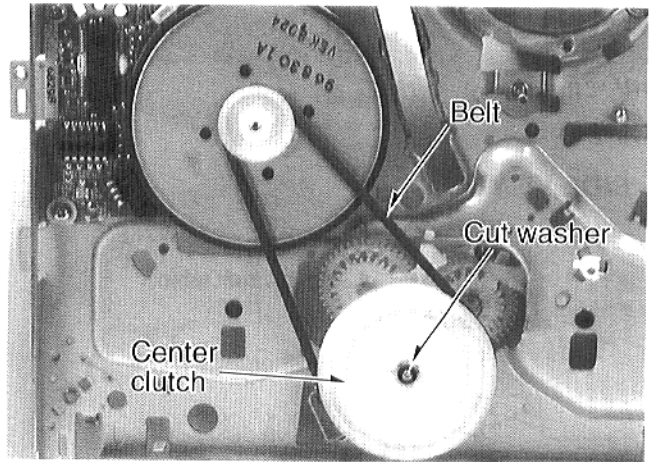

Fig. C16

BOTTOM VIEW

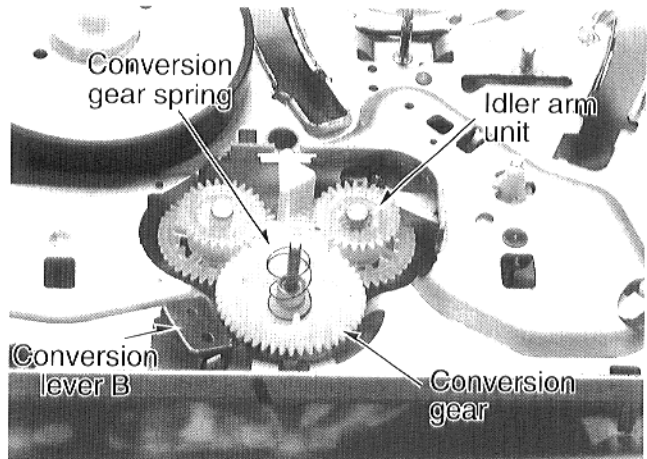

Fig. C17

12. Removal of Capstan unit

Remove 3 gold screws (Fig. C18).

Remove 2 gold screws on the bottom of Chassis (Fig. C19).

Keep moving SS brake arm and remove Capstan unit.

TOP VIEW



Fig. C18

BOTTOM VIEW



Fig. C19

13. Removal of Cylinder unit

Remove red screw (Fig. C20).

Remove 3 gold screws on the bottom of Chassis and remove Cylinder unit (Fig. C21).

TOP VIEW

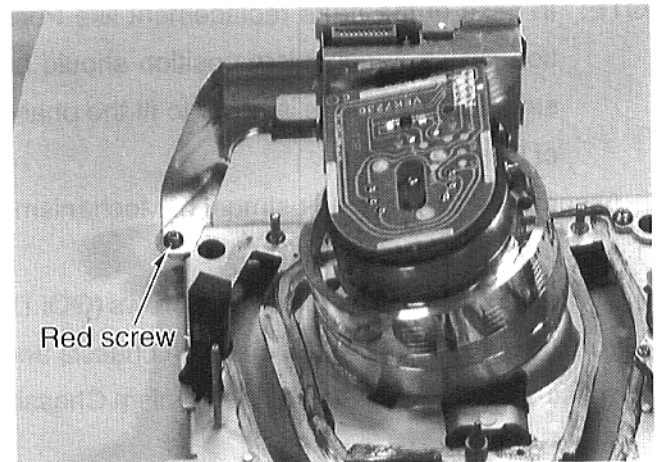

Fig. C20

BOTTOM VIEW

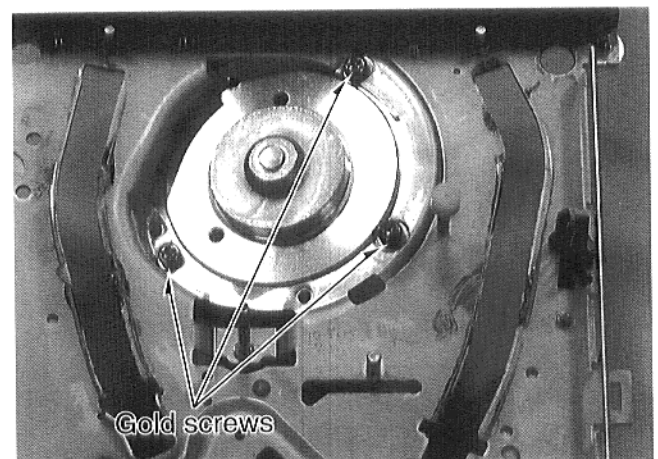

Fig. C21

4-2. Assembly and phase adjustment of mechanism

The gear phase alignment has been performed in the EJECT position and it is crucial for the Z Mechanism to operate correctly.

NOTE: In case of the parts replacement like Position switch, Mechanism position should be set to Eject position in order to fit the phase of Position switch.

1. Assembly and phase adjustment of Mechanism

(1) Assembly of Cylinder unit

Cylinder unit should be fixed by 3 screws (GOLD) from the bottom side of Mechanism chassis and red screw on the top side of Mechanism Chassis (Fig. E1, E2).

BOTTOM VIEW

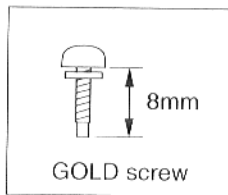

Fig. E1

TOP VIEW

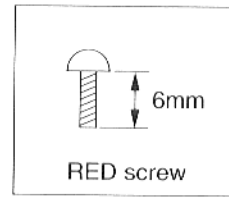
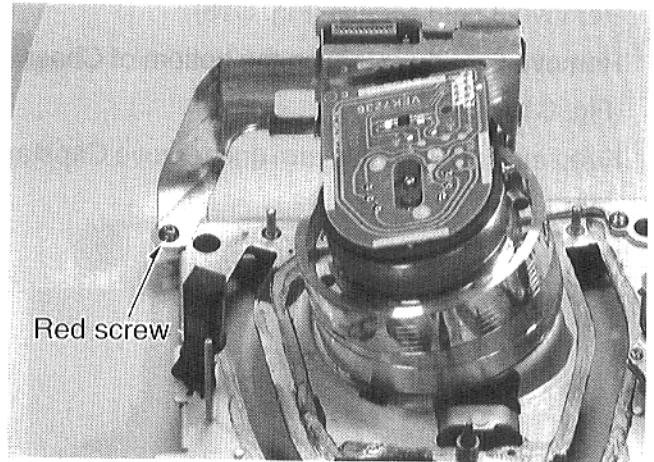

Fig. E2

(2) Assembly of Capstan unit

Move SS brake arm in the direction of arrow (see Fig. E3) and capstan unit should be fixed by 2 screws (GOLD) on the bottom side of Mechanism chassis and 3 screws (GOLD) on the top of Mechanism chassis (Fig. E3, E4).

BOTTOM VIEW

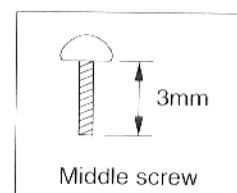
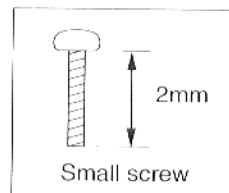
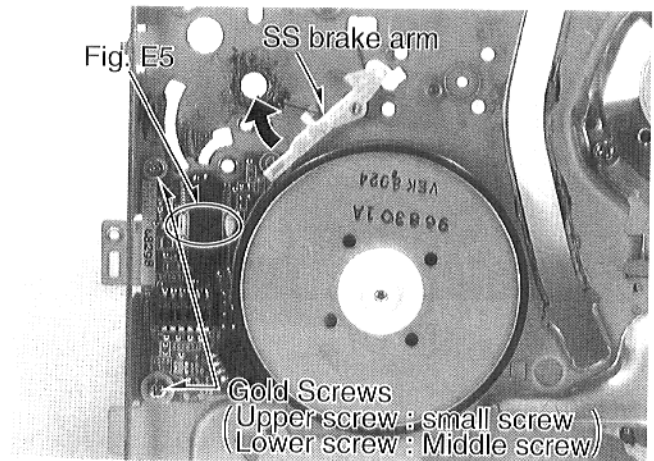

Fig. E3

TOP VIEW

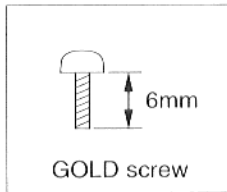
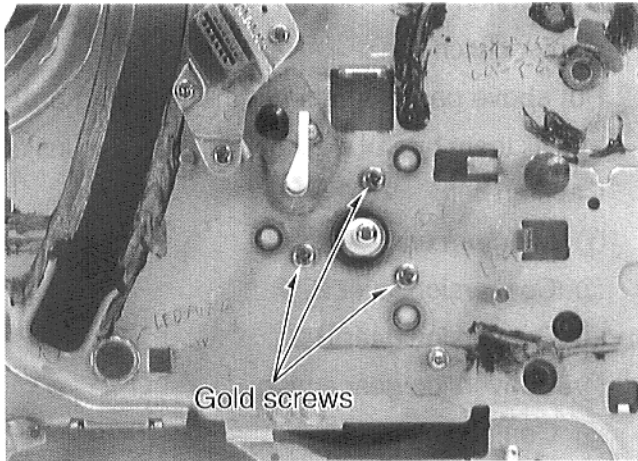

Fig. E4

NOTE: Replacement of Capstan unit and Procedure of applying the silicone grease.

REPLACEMENT OF CAPSTAN UNIT

In case of replacement of the Capstan Unit the Silicone grease have to be applied between the Mechanism chassis and the Drive IC by the following procedure.

Silicone grease No. VFK1301 for radiation of the Drive IC

Silicone grease is used for the radiation of the Drive IC. The heat occurred on the IC is radiated to the Mechanism chassis through the grease. In case of the incomplete radiation, the safety circuit operates depending on the rise of the temperature and it possibility stop the operation of the Drive IC.

PROCEDURE OF APPLYING THE SILICONE GREASE

- ① There is a cut-out part at the Drive IC mounting position and the bottom of the IC can be seen from the cut-out part. Apply the Silicon grease to whole the cut-out part of IC as shown in Fig. E5-1 so that the grease is piled 0.3–0.5 mm from the surface of the C.B.A.
- ② Next, from the component side of the C.B.A., apply the Silicon grease so that the grease is piled at the metal of the center of the IC as shown in Fig. E5-2.

SIDE VIEW

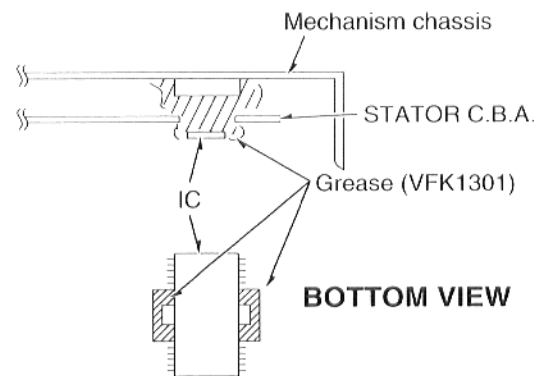

Fig. E5

TOP VIEW

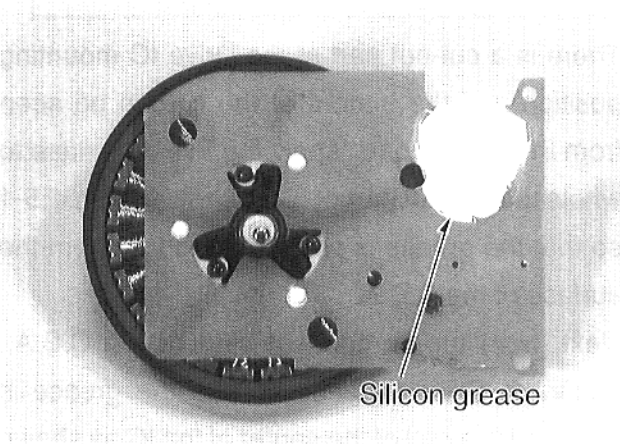

Fig. E5-1

Fig. E5-1. Apply the Silicon grease so that the grease is piled 0.3–0.5 mm from the surface of the C.B.A.

BOTTOM VIEW

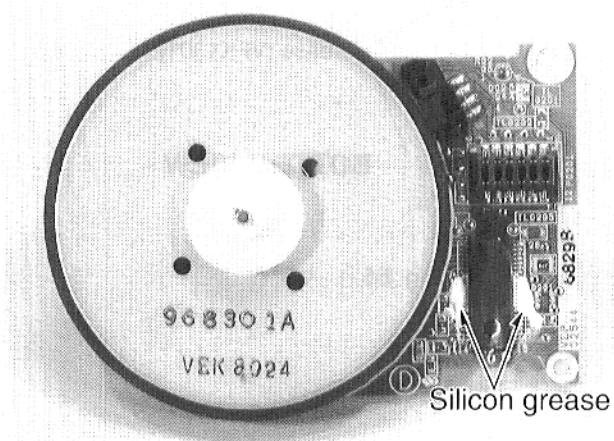

Fig. E5-2

Fig. E5-2. Apply the Silicon grease at the metal of the center of the IC.

(3) Assembly of Idler arm unit, Conversion lever B, Conversion gear, Conversion gear spring and Center clutch

Put above parts together in the following order and fix them by Cut washer (Fig. E6), and install Capstan belt.

- ① Idler arm unit
- ② Conversion lever B
- ③ Conversion gear
- ④ Conversion gear spring
- ⑤ Center clutch

BOTTOM VIEW

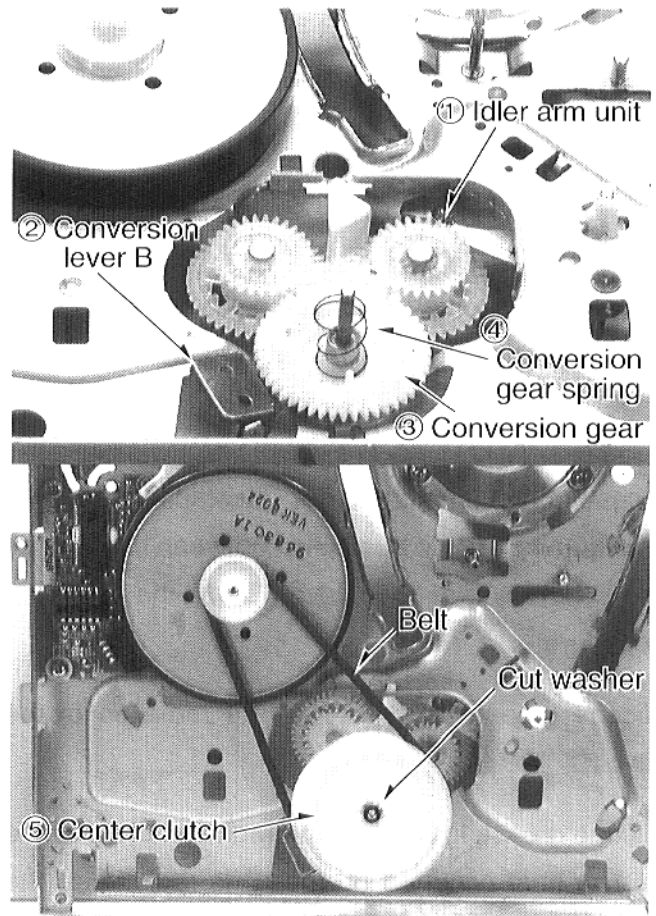

Fig. E6

- (4) Assembly of Loading rack, Take-up & Supply shaft holder and Prism LED

Adjust the phase between the hole of Loading rack position fixture and the penetration hole of Chassis. Install Take-up and Supply shaft holder so that Take-up and Supply shaft holder fits the groove of Chassis.

Put Prism LED together (Fig. E7).

TOP VIEW

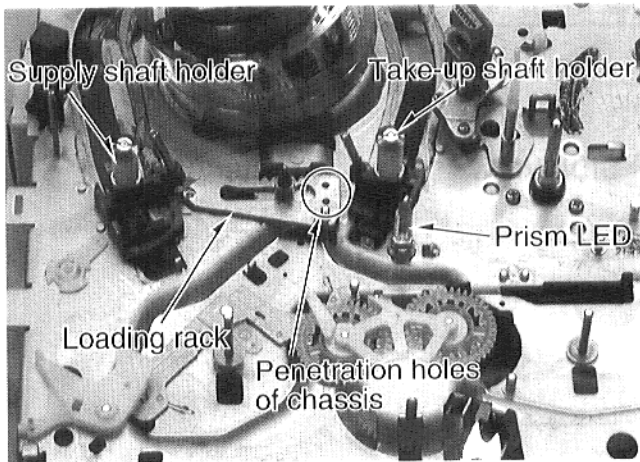

Fig. E7

- (5) Assembly of Take-up and Supply Loading arm
 Move Shaft holder to the unloading position. Adjust the phase of Take-up and Supply loading arm and insert the arm to the shaft (Fig. E8).

BOTTOM VIEW

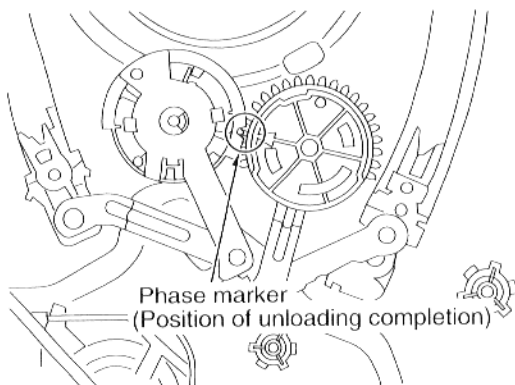

Fig. E8

- (6) Assembly of Take-up reel table and Take-up brake arm unit

Put washer, (Fig. E10) Take-up reel table and Take-up brake arm unit together (Fig. E9).

NOTE: The shape between portion A for Take-up reel table and portion B for Supply reel table is different.

Therefore, confirm the shape of portion A and B before mounting reel tables. If Take-up reel table has been confused with Supply reel table and they have been installed, the trouble of reel table rotation slip happens (Fig. E11).

TOP VIEW

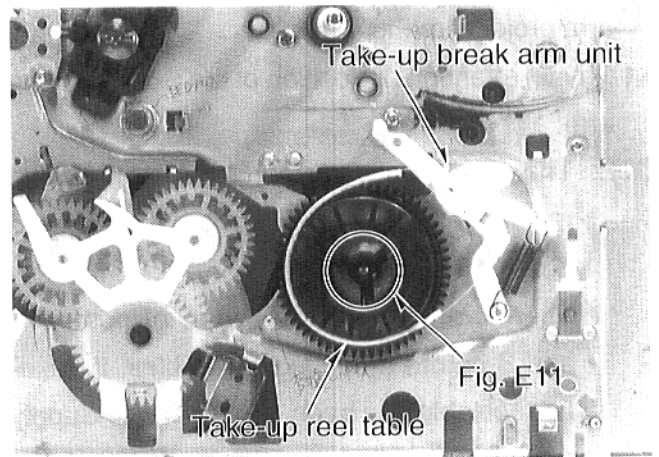

Fig. E9

SIDE VIEW

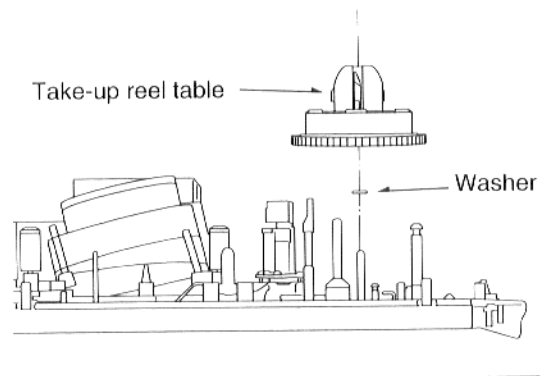

Fig. E10



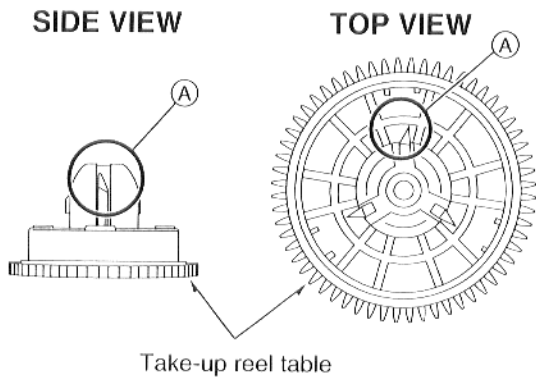

Fig. E11

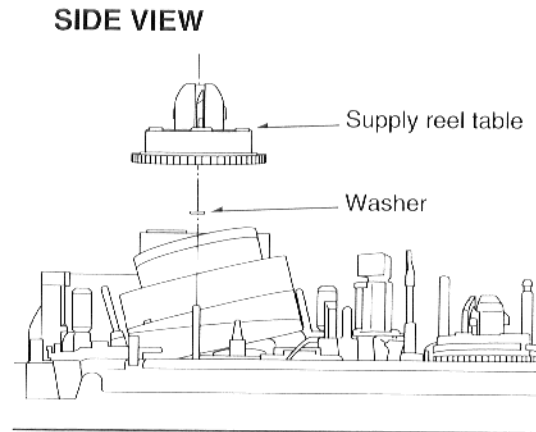

Fig. E13

(7) Assembly of Supply reel table and Tension arm unit

Install washer (Fig. E13) and Supply reel table. Insert Tension arm unit to Tension arm projection and hang Tension spring with Supply spring arm projection (Fig. E12).

※1 Pay an attention of Position of the Supply spring arm.

NOTE: The shape between portion A for Take-up reel table and portion B for Supply reel table is different.

Therefore, confirm the shape of portion A and B before mounting reel tables. If Take-up reel table has been confused with Supply reel table and they have been installed, the trouble of reel table rotation slip happens (Fig. E14).

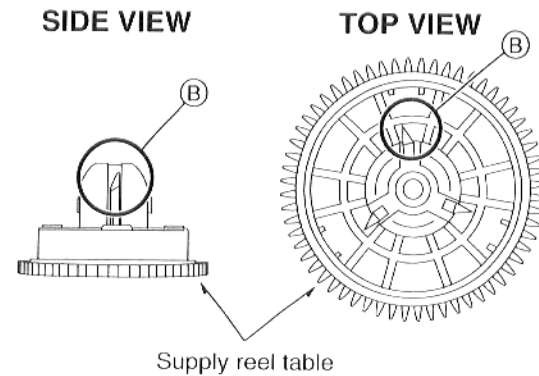

Fig. E14

(8) Assembly of Drive main lever arm

Install Drive main lever arm so that Drive main lever arm fits to the groove of Chassis.

And rotate Drive main lever arm to the clockwise in order to adjust the phase between the hole of the position fixture and the penetration hole of Chassis (Fig. E15).

TOP VIEW



Fig. E12

TOP VIEW

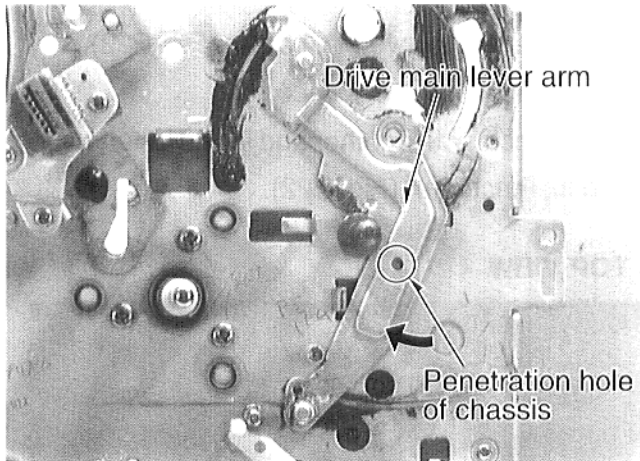

Fig. E15

TOP VIEW

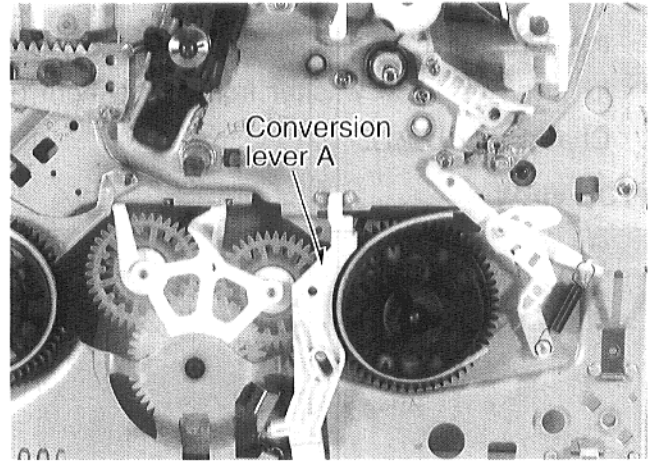

Fig. E17

(9) Assembly of Conversion lever A, P5 arm and Main lever

Install Conversion lever A and P5 arm (Fig. E16, E17).

Adjust the phase of Main lever so that Main lever fits the projection of Loading rack.

Main lever has to be locked at the projection of Chassis by 1 tab, and 2 tabs of Prism LED (Fig. E16).

- ※ Conversion lever A, P5 arm, Supply brake arm unit and the projection of Take-up brake arm have to be installed to the groove under the Main lever (Fig. E18).

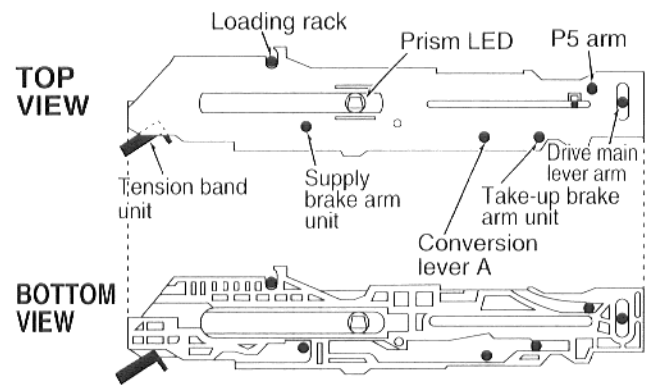

Fig. E18

TOP VIEW

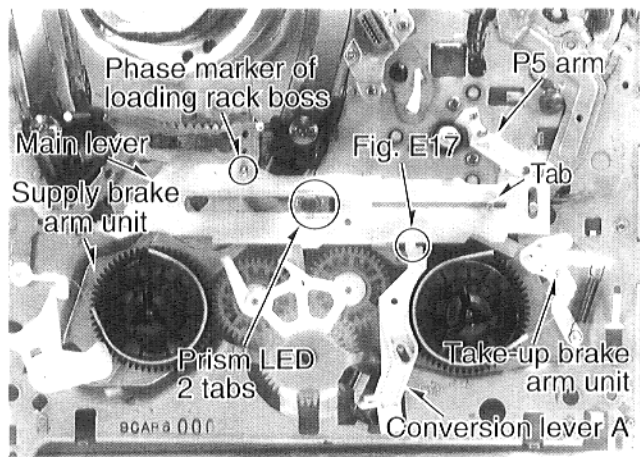

Fig. E16

(10) Assembly of Drive rack arm

Install Drive rack arm so that Drive rack arm fits the groove of Chassis and rotate it to the clockwise in order to fit the penetration hole of Chassis (Fig. E19).

TOP VIEW

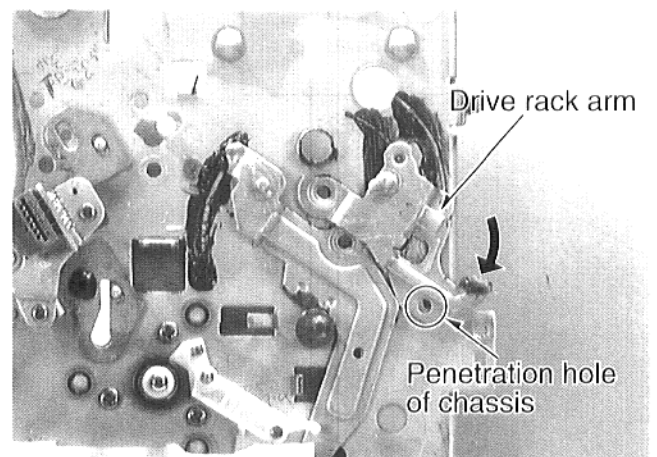

Fig. E19

(11) Assembly of Main cam gear

Install Main cam gear so that Main cam gear fits the penetration hole of Chassis (Fig. E20) and fix it by the snap washer from the bottom of Chassis (Fig. E21).

TOP VIEW



Fig. E20

BOTTOM VIEW

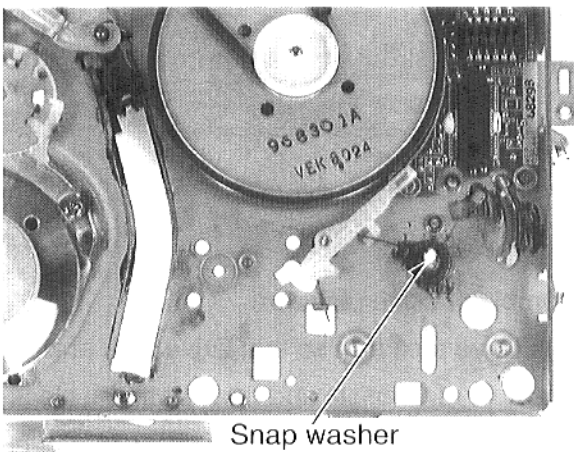

Snap washer

Fig. E21

(12) Assembly of Loading motor unit

Install Loading motor unit so that Loading motor unit fits the groove of Chassis (Fig. E22).

(13) Assembly of Pinch arm

Put Pinch arm together and install Opener piece to fix Pinch arm (Fig. E22).

TOP VIEW

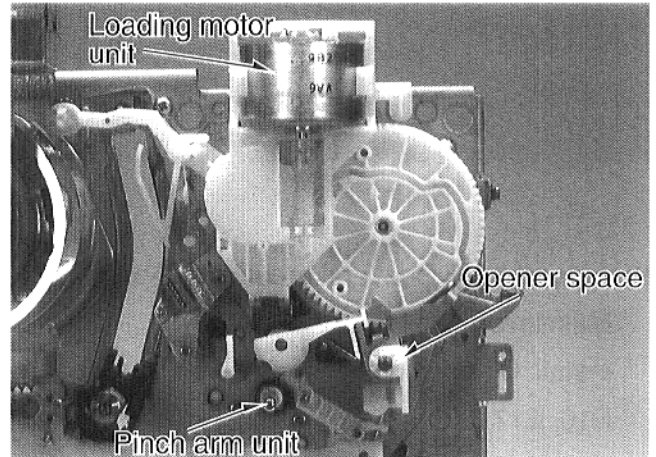

Fig. E22

4-3. Assembly of mechanism chassis

1. Assembly of Mechanism chassis

(1) Adjust the phase of Position switch in Main C.B.A..

Rotate Position switch until the click point. The projection of Position switch should be set to just above (Fig. F1).

TOP VIEW

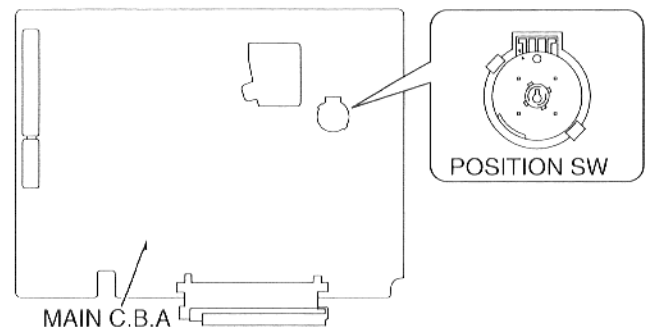

Fig. F1

(2) Assembly of Mechanism chassis

Put Mechanism chassis on Main C.B.A. and fix it by 5 screws (3 red screws and 2 gold screws). Connect P3001, P2502 and P4002 (Fig. F2).

TOP VIEW

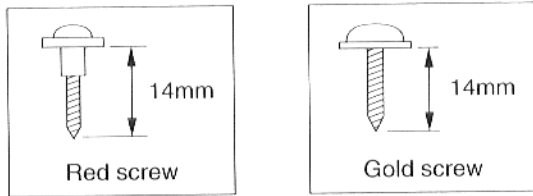
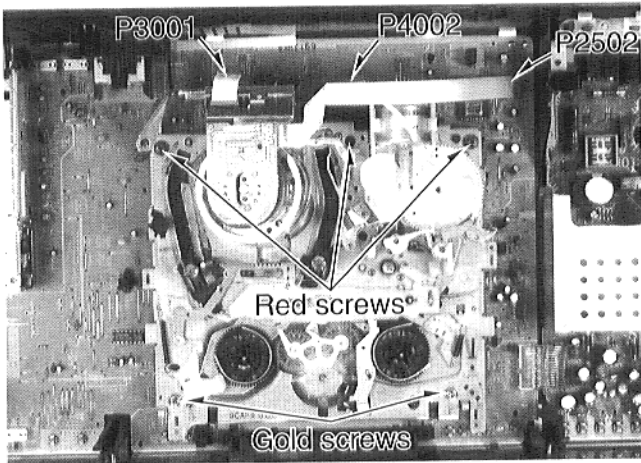

Fig. F2

※ The red screws has a gap among the chassis. Therefore be careful not to tighten too much.

2. Assembly of Cassette holder unit

(1) Assembly of Main shaft

Install Main shaft so that Main shaft fits the groove of Chassis (Fig. F3).

TOP VIEW

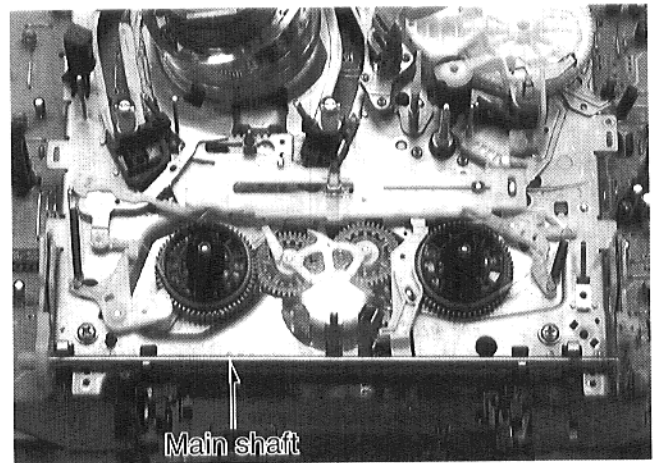

Fig. F3

(2) Assembly of Left & Right side plate

Install Left side plate so that Left side plate fits the groove of Chassis and fix it by the red screws.

After adjustment the phase of waper arm and Drive rack (Fig. F5), install Right side plate so that Right side plate fits the groove of Chassis and fix it by 2 red screws. Hang connection spring on the projection of Drive rack arm (Fig. F4, F5).

TOP VIEW

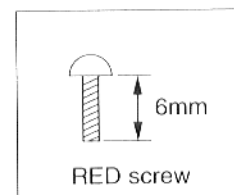
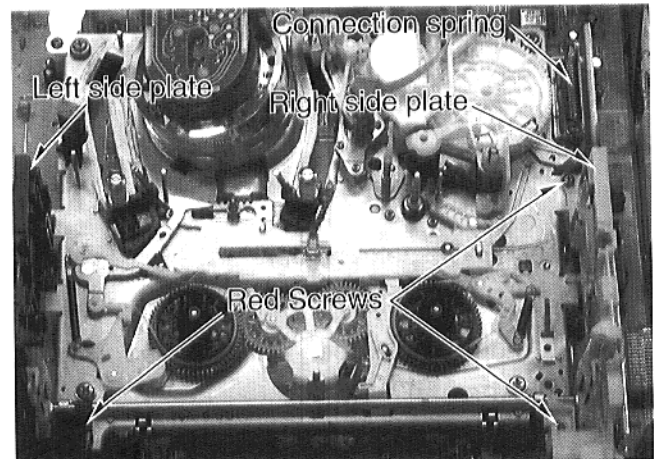

Fig. F4

SIDE VIEW

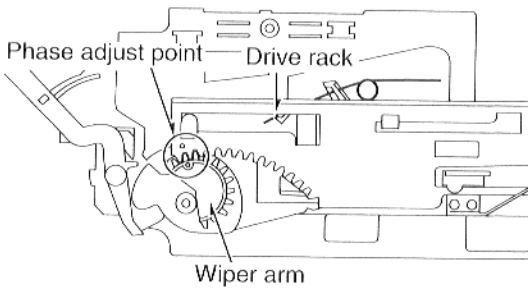

Fig. F5

TOP VIEW

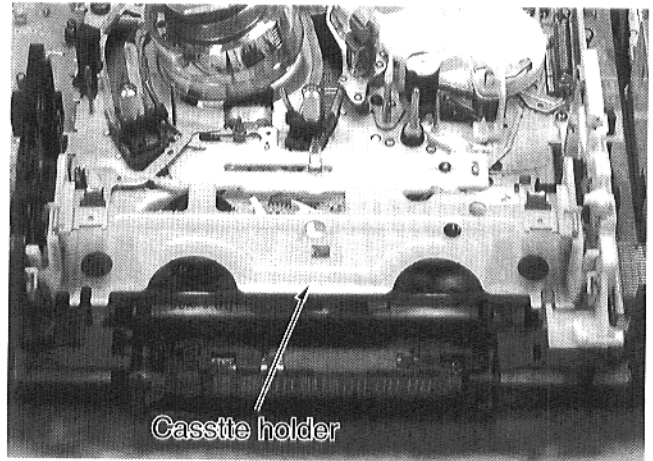

Fig. F7

TOP VIEW

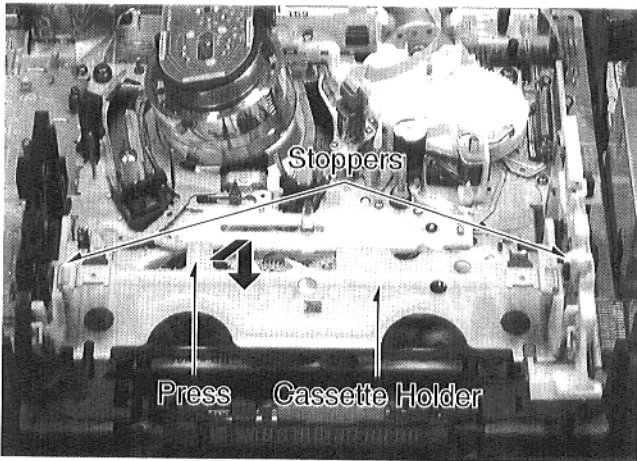

Fig. F6

(3) Assembly of Cassette holder

Install Cassette holder so that Cassette holder fits the groove of Waper arm installed in Main shaft (Fig. F6, F7).

(4) Assembly of Top plate

Install Top plate so that Top plate fits the groove of Left and Right side plate.

- ※ Fix Top plate by tightening screw when the tabs of Left and Right side plate broke (Fig. F8).

TOP VIEW

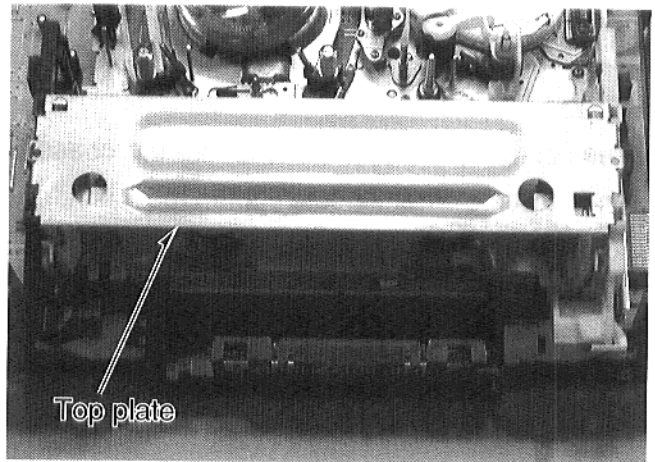
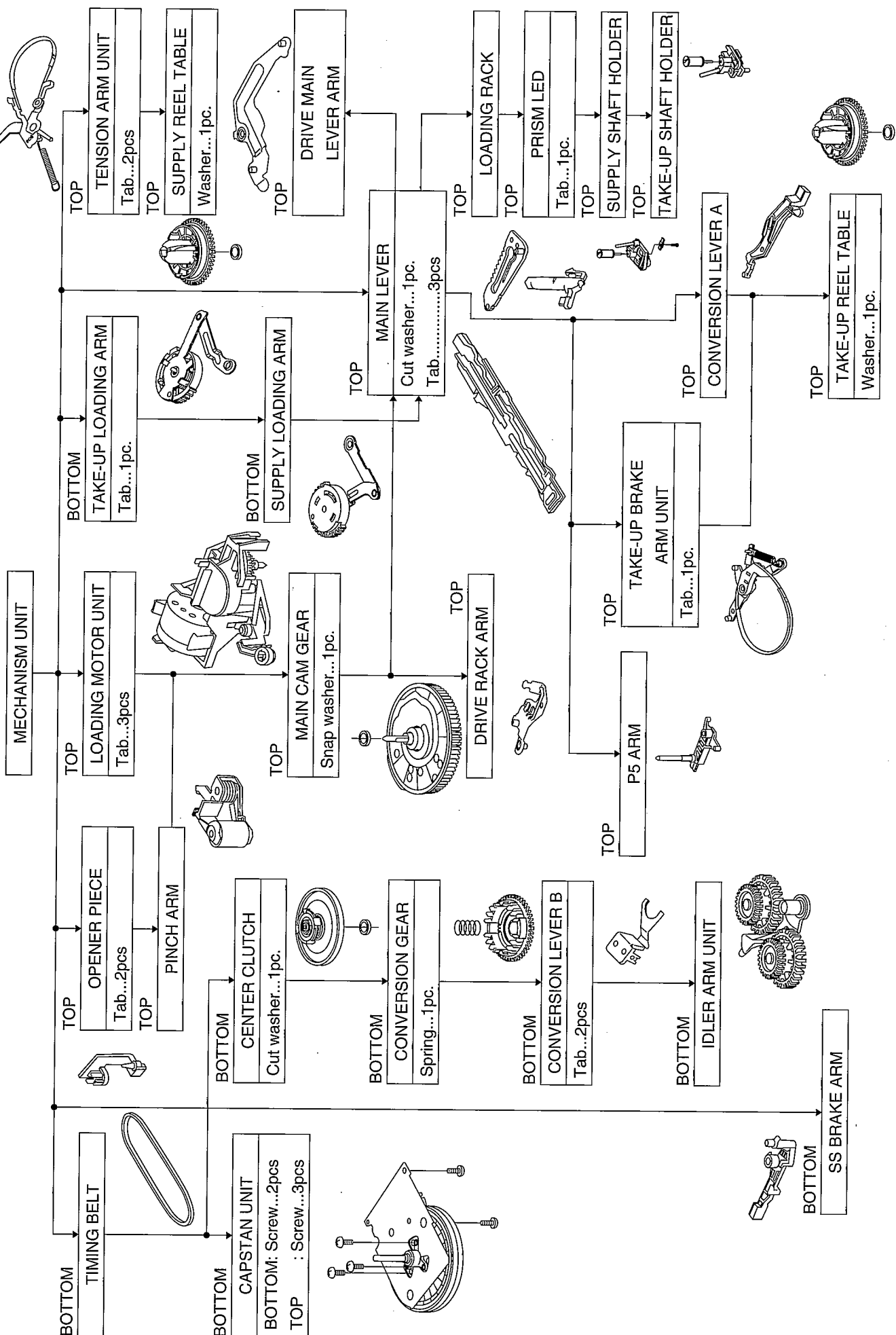

Fig. F8

(5) Install Front panel unit and Top panel

Parts Access Flow Chart



5. MECHANICAL ADJUSTMENT PROCEDURE

5-1. Tension post position adjustment

Equipment required: Hex. Wrench (VFK0326)
Specification: 50.5 ± 1.5 mm

- (1) Disconnect the AC plug.
- (2) Remove the TOP PLATE.
- (3) Turn the LOADING MOTOR until the loading completes.
- (4) Adjust the hole of Tension Band Fastener by Hex Wrench until the distance between the Tension Post and the center of Supply reel table is 50.5 ± 1.5 mm as shown in Fig. M1.

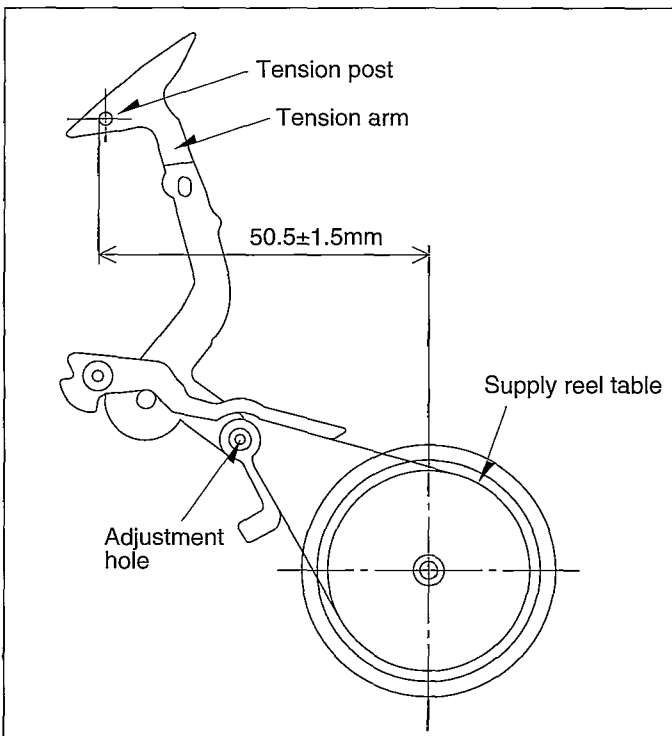

Fig. M1

5-2. Back tension adjustment

Equipment required:
Back Tension Meter (VFK0132)
VHS Cassette tape (180 minutes tape: PAL)
VHS Cassette tape (120 minutes tape: NTSC)
Specification: 22.5–27.5g

- (1) Playback the cassette tape from the beginning and wait until the tape movement get the stabilization. (for approx. 10–20 seconds)
- (2) Insert the Back Tension Meter into the path of a tape, and measure the back tension to be within specification as shown in Fig. M2.

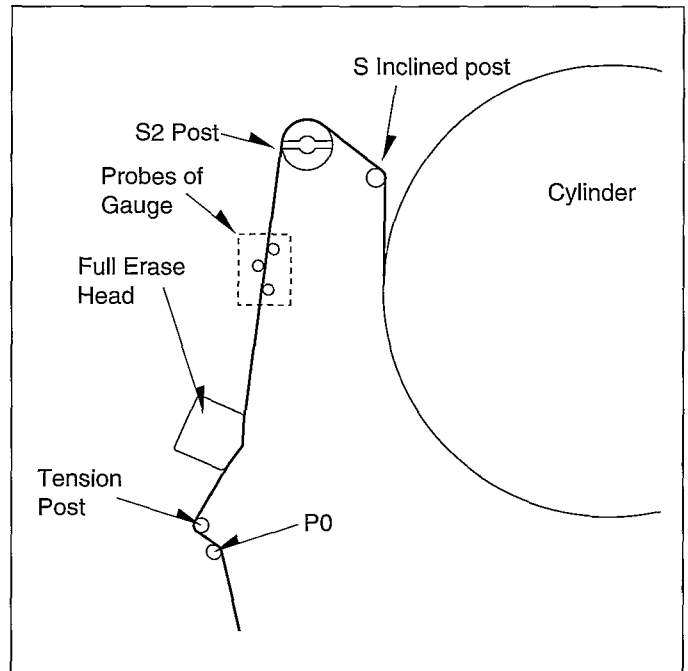

Fig. M2

- (3) If it is out of specification, change the spring notch as shown in Fig. M3.

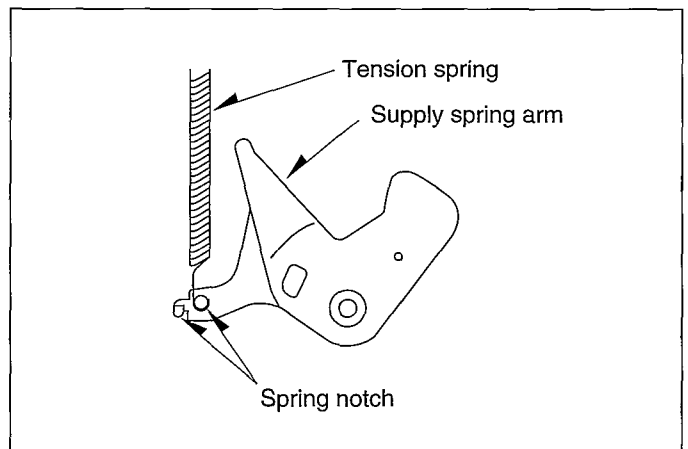

Fig. M3

5-3. P2 and P3 posts adjustment (PREADJUSTMENT)

Equipment Required:

Post Adjustment Screwdriver (VFK0329)

- (1) Remove the Top Plate.
- (2) Turn the Loading Motor until the unloading completes.
- (3) Rotate the P2 and P3 Posts clockwise to the end. (Fig. M4)
- (4) Rotate the P2 and P3 Posts twice counterclockwise. (Fig. M4)

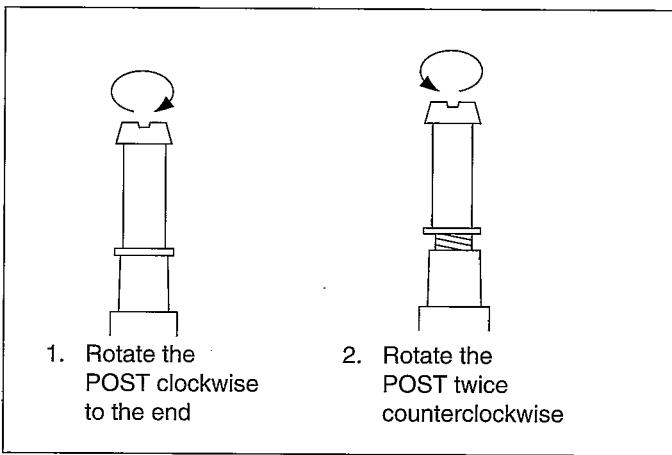

Fig. M4

- (5) Playback the cassette tape and make sure that the edges of the tape are not curling at the bottom or top end of the P2, P3, and P4 Posts as shown in Fig. M5.

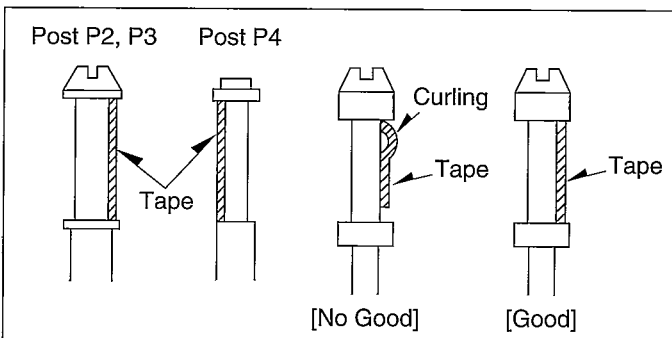

Fig. M5

- (6) If the curling appears, readjusts the P2 and P3 Posts.

5-4. Tape interchangeability adjustment

Carry out the following procedures for Tape Interchangeability Adjustment to do it correctly and smoothly.

- (1) P2 AND P3 POSTS ADJUSTMENT
- (2) ADJUSTMENT OF P4 POST
- (3) HEIGHT ADJUSTMENT OF A/C HEAD
- (4) FINE-ADJUSTMENT OF A/C HEAD
- (5) ADJUSTMENT OF X-VALUE (PREADJUSTMENT)
- (6) FINE-ADJUSTMENT OF X-VALUE

If the Tape Interchangeability Adjustment is not perfect, repeat the above procedures from (1) to (6).

CAUTIONS: To make an Adjustment Mode for Tape Interchangeability, press the FF and EJECT buttons simultaneously 3 times to set the Service Mode 2.

In case of VCR mounted shuttle ring, turn the shuttle ring to FF and then press EJECT button.

In Loewe model, STOP button is used instead of FF button.

NOTE: Cleaning the Tape Transport path before adjusting of Tape Interchangeability. The detail portion is shown below.

P0 Post, Tension Posts, FE Head, P2 Post, Supply Inclined Post, Cylinder Unit, Take-up Inclined Post, P3 Post, A/C Head, P4 Post, Pinch Roller, Capstan Shaft, P5 Post. FE Head, Cylinder Unit, A/C Head and Capstan Shaft are more important parts and pay an attention to clean them.

5-4-(1). P2 AND P3 POSTS ADJUSTMENT

Equipment required:

Alignment Tape (PAL/SECAM: VFJ8125H3F)

(NTSC: VFM8080HQFP)

Post Adjustment Screwdriver (VFK0329)

- (1) Connect the oscilloscope to the output of the Head Amp as shown in Fig. M6.

NOTE: To get a stable waveform of the Head Amp output (observation point TW3001 and TW2001 located on Main C.B.A.) on the oscilloscope, use the head switching pulse as a triggering signal as shown in Fig. M6.

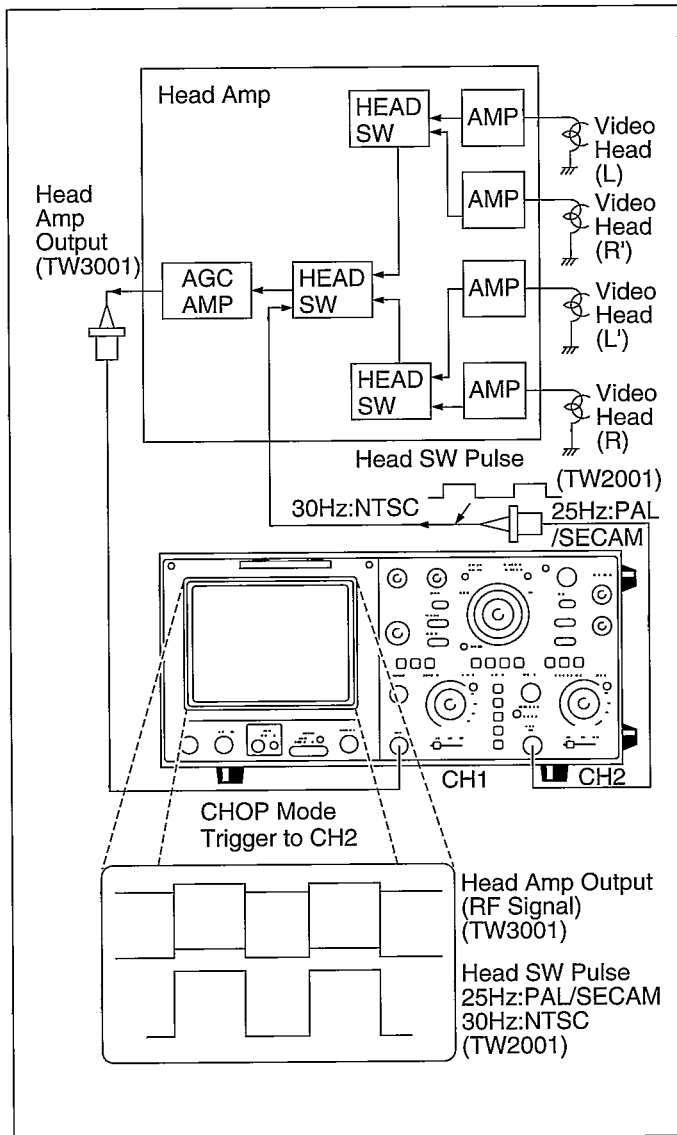

Fig. M6 Connect of Oscilloscope

- (2) Playback the Alignment Tape.
- (3) If the RF envelope appears like example "A" or "B" in Fig. M7, then adjustment of the tape guide post (P2: Entrance) is necessary.
- (4) Adjust the tape guide post (P2) with the post adjustment screwdriver so that the RF envelope at the entrance portion becomes flat as shown in Fig. M7 "C".

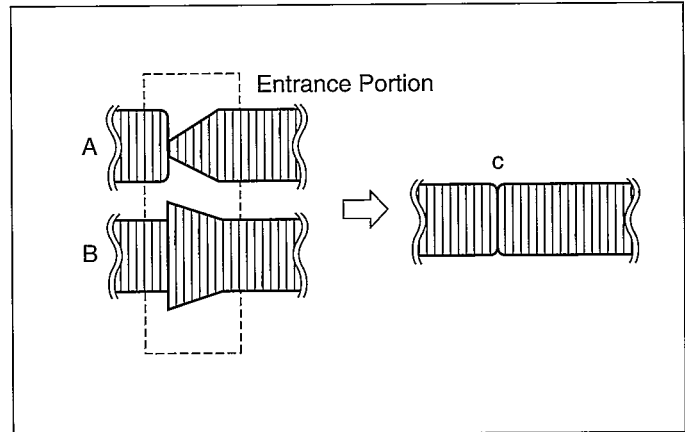

Fig. M7

- (5) If the RF envelope appears like "D" or "E" in Fig. M8, then adjustment of the tape guide post (P3: Exit) is necessary.
- (6) Adjust the tape guide post (P3) in the same manner as the P2 post so that the exit portion becomes flat as shown in Fig. M8 "F".

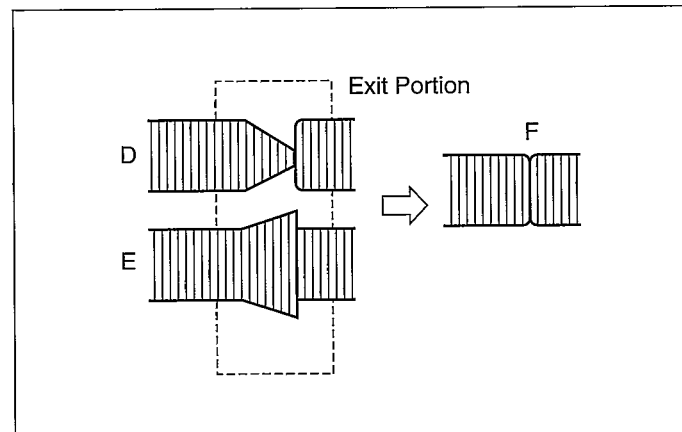

Fig. M8

- (7) Keep pressing the tracking up/down (\wedge or \vee) buttons on the remote controller unit. The output envelope should vary nearly parallel with other condition as shown in Fig. M9.
- (8) Set the tracking control into center fix position by pressing the tracking up/down (\wedge and \vee) simultaneously and adjust for maximum RF envelope, whilst being as flat as possible.

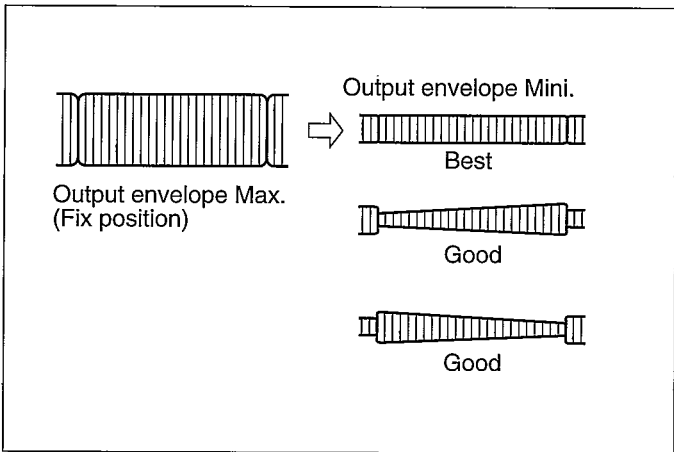

Fig. M9

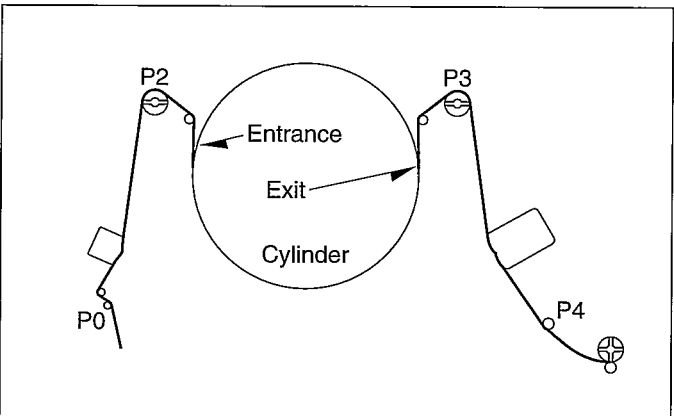

Fig. M10 Loading of Posts

5-4-(2). ADJUSTMENT OF P4 POST

- (1) Install A/C Head on the Mechanism Chassis by one screw.
- (2) Playback the Alignment Tape.
- (3) Rotate the screw (A) or (B) until the wrinkle appears on the lower edge of tape at P4 Post.
- (4) Rotate the screw (A) or (B) until the wrinkle just disappears on the lower edge of tape at P4 Post.
- (5) Connect the oscilloscope to audio output terminal.
- (6) Rotate the screw (C) until audio signal is maximized.

- NOTE: 1. The relation between the rotation direction of screws (A) and (B) and the condition of wrinkle on the lower edge at P4 Post as shown in Fig. M11.
2. Make sure that there is not the inclined wrinkle between P4 Post and Pinch Roller.

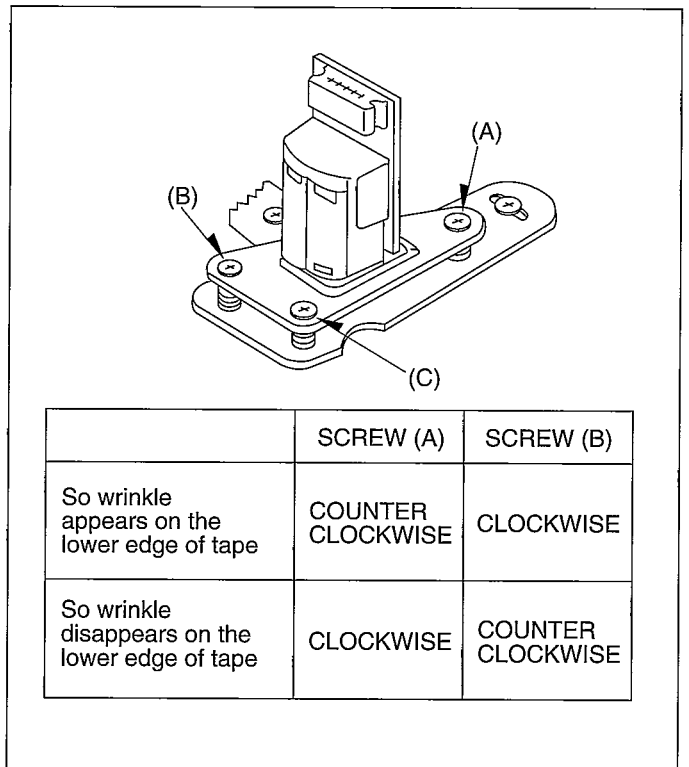

Fig. M11

5-4-(3). HEIGHT ADJUSTMENT OF A/C HEAD

<When moving the A/C Head up>

- (1) Rotate the screw (A) counterclockwise until the wrinkle appears on the lower edge of tape at P4 Post.
- (2) Rotate the screw (B) counterclockwise until the wrinkle just disappears on the lower edge of tape at P4 post.
- (3) Rotate the screw (C) counterclockwise until the audio signal is maximized.

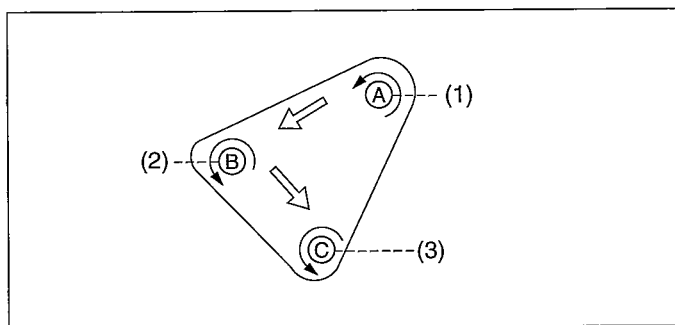

Fig. M12

<When moving the A/C Head down>

- (1) Rotate the screw (B) clockwise until the wrinkle appears on the lower edge of tape at P4 Post.
- (2) Rotate the screw (A) clockwise until the wrinkle just disappears on the lower edge of tape at P4 post.
- (3) Rotate the screw (C) clockwise until the audio signal is maximized.

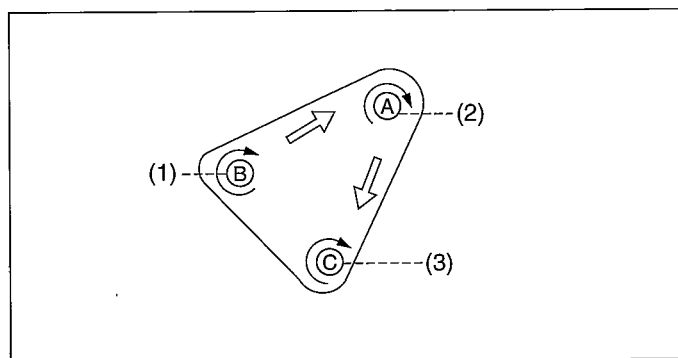

Fig. M13

5-4-(4). FINE-ADJUSTMENT OF A/C HEAD

- (1) Connect the oscilloscope to the output of the Head Amp as shown in Fig. M6.
- (2) Playback the Alignment Tape.
- (3) Make sure that the condition of the wrinkle at P4 Post. If the condition of the wrinkle is out of specification, P4 Post adjustment has to be performed as follows.
Turn the screw (A) counterclockwise until the wrinkle appears on the lower edge of tape at P4 Post.
Turn the screw (A) clockwise until the wrinkle disappears on the lower edge of tape at P4 Post.
- (4) Turn the screw (C) until the audio signal is maximized.

NOTE: Make sure that the audio output does not increase when push the upper and lower edges of tape around A/C Head.

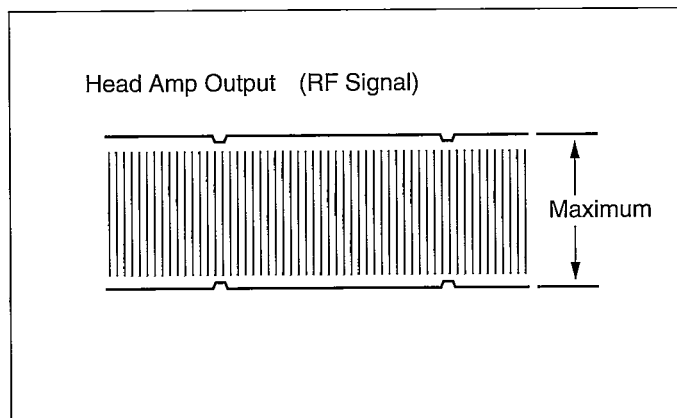

Fig. M14

5-4-(5). ADJUSTMENT OF X-VALUE (PREADJUSTMENT)

Equipment required:

Fine Adjustment Gear Drive (VFK0330)

Specification: Less than 15 msec.

- (1) Connect the oscilloscope to the audio output and the video output. Both output signals should be fixed by the external trigger.

- (2) Playback the Alignment Tape and set the tracking control into center fix position.
- (3) Adjust A/C Head position by the Fine Adjustment Gear Driver (VFK0330) to meet the signal fault portion of the audio output and the video output signals (Less than 15 msec.).
- (4) After meeting the signal fault portion, adjust A/C Head position by the Fine Adjustment Gear Driver (VFK0330) until the video envelope is maximized.

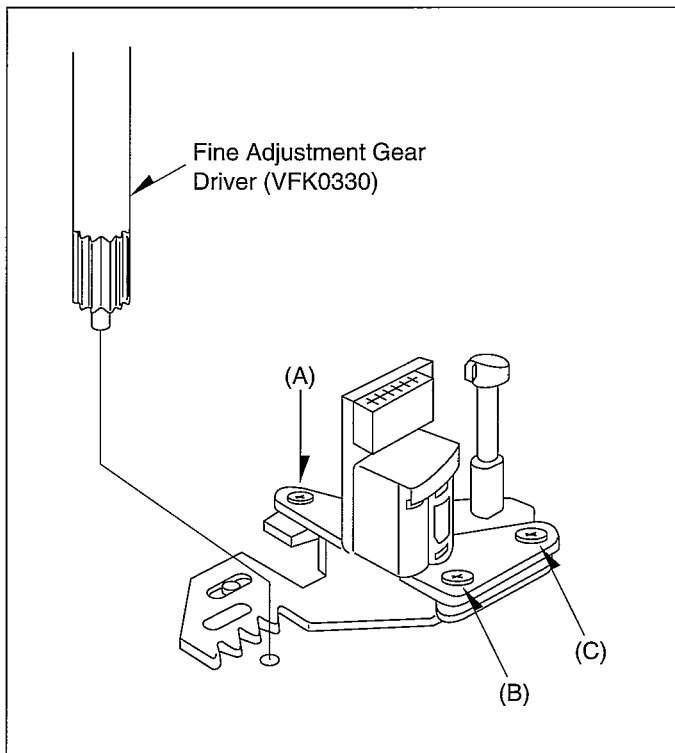

Fig. M15

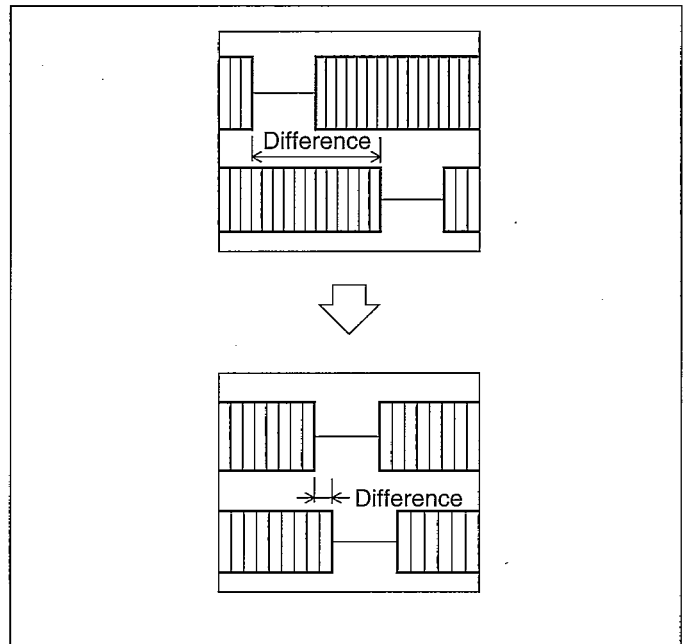

Fig. M16

5-4-(6). FINE-ADJUSTMENT OF X-VALUE

Equipment required:

Fine Adjustment Gear Drive (VFK0330)

- (1) Connect the oscilloscope to the audio output and the video output. Both output signals should be fixed by the external trigger.
- (2) Playback the alignment tape and set the tracking control into center fix position.
- (3) Adjust A/C Head position by the Fine adjustment Gear Driver (VFK0330) until the video envelope level is maximized at the tracking center fix position.

NOTE: During X-Value Fine Adjustment, in case the video envelope level became 0, Preadjustment of X-value should be adjusted again due to it is possibility to vary the X-value adjustment.

Servicing Fixtures & Tools

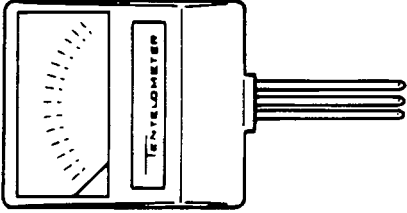
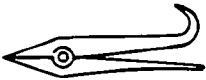
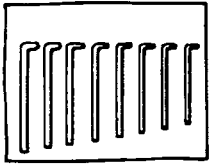
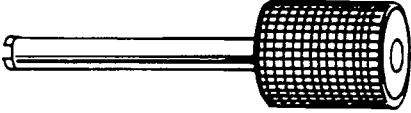
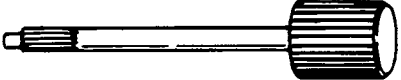
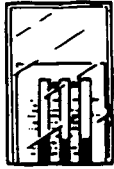
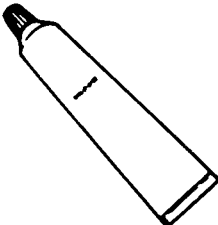
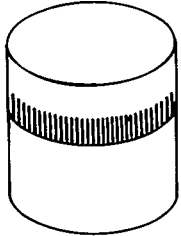
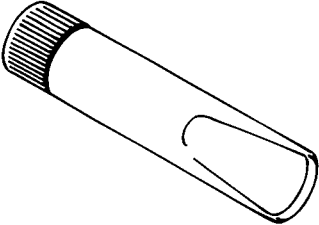
<p>VFJ8125H3F PAL VHS Alignment Tape</p> <p>VFM8080HQFP NTSC VHS Alignment Tape</p> 	<p>VFK0132 Back Tension Meter (Tentelometer, Made in U.S.A.)</p> 	<p>VFK0335 Retaining Ring Remover (3mm/4mm)</p> 
<p>VFK0326 Hex. Wrench Set (0.7, 0.9, 1.2, 1.5, 1.6, 2.0, 2.4, 3.0mm)</p> 	<p>VFK0329 Post Adjustment Screwdriver</p> 	<p>VFK0330 Fine Adjustment Gear Driver</p> 
<p>VFK27 Hand Cleaning Stick</p> 	<p>VFK1024 Morlytone Grease</p> 	<p>VFK1298 Floil Grease</p> 
<p>VFK1301 Silicone Grease</p> 		

6. SELF-TEST INDICATION DISPLAY

This VTR has a self-diagnosis and display function. If the VTR detects trouble during installation or during use, one of the following fault indication codes will automatically appear in the VTR display. Fault indication codes are displayed in the form of a single English letter followed by two numbers, as for example "H01".

Note: 1. The indication "U" is displayed on the FIP while power remains on.

2. Otherwise, the indication "H" or "F" is displayed on the FIP, and the power is automatically turned off.

When the power is turned on again, the fault indication code will disappear and the unit will return to normal display mode (either clock or counter is displayed).

3. This fault indication code will be stored in the microprocessor even with the AC plug disconnected.

The two-digit number portion of the stored fault indication code can be redisplayed in the FIP's "second" display portion (the last 2 digits on the light) by placing the unit in Service Mode Number 2 when turning on Service Information Display as for example "01" or "02" etc.

If a second error occurs, only the most recent error will be displayed and stored.

4. To erase the stored fault indication code data, press FF and EJECT buttons for 5 seconds.

< FIP >



INDICATION	CAUSE	REMEDY/CHECK
U 10	Dew formation.	Wait until the indication disappears.
H 01	After cylinder lock is detected, the cylinder does not start rotating again even after tape unloading.	Check the cylinder unit and the cylinder motor drive circuit.
H 02	Cassette tape is not wound up during tape unloading except Eject mode.	Check the capstan unit and the capstan motor drive circuit.
F 03	Mechanism locks during mode transition except Eject mode.	1. Check the loading motor drive circuit. 2. Check the mechanism phase alignment. 3. Check the mode switch.
F 04	Mechanism locks during tape unloading.	1. Check the loading motor drive circuit. 2. Check the mechanism phase alignment.
F 06	Mechanism locks after tape unloading in Eject mode.	1. Check the loading motor drive circuit. 2. Check the mechanism phase alignment for cassette holder unit.
F 07	During recording mode recording signal is less than the normal condition.	Protection of the overcurrent flowing in transistor which produce the power supply for recording mode.
F 08	Recording circuit works except recording mode.	Check the recording circuit.
H 16	Cylinder lock detection.	Check the cylinder unit and the cylinder motor drive circuit.
H 17	Supply reel mechanism lock detection.	Check the supply reel mechanism and the supply reel circuit.
H 18	Take-up reel mechanism lock detection.	Check the take-up reel mechanism and the take-up reel circuit.

Fig. T1 Self-Test indication Display

7. SERVICE INFORMATION DISPLAY

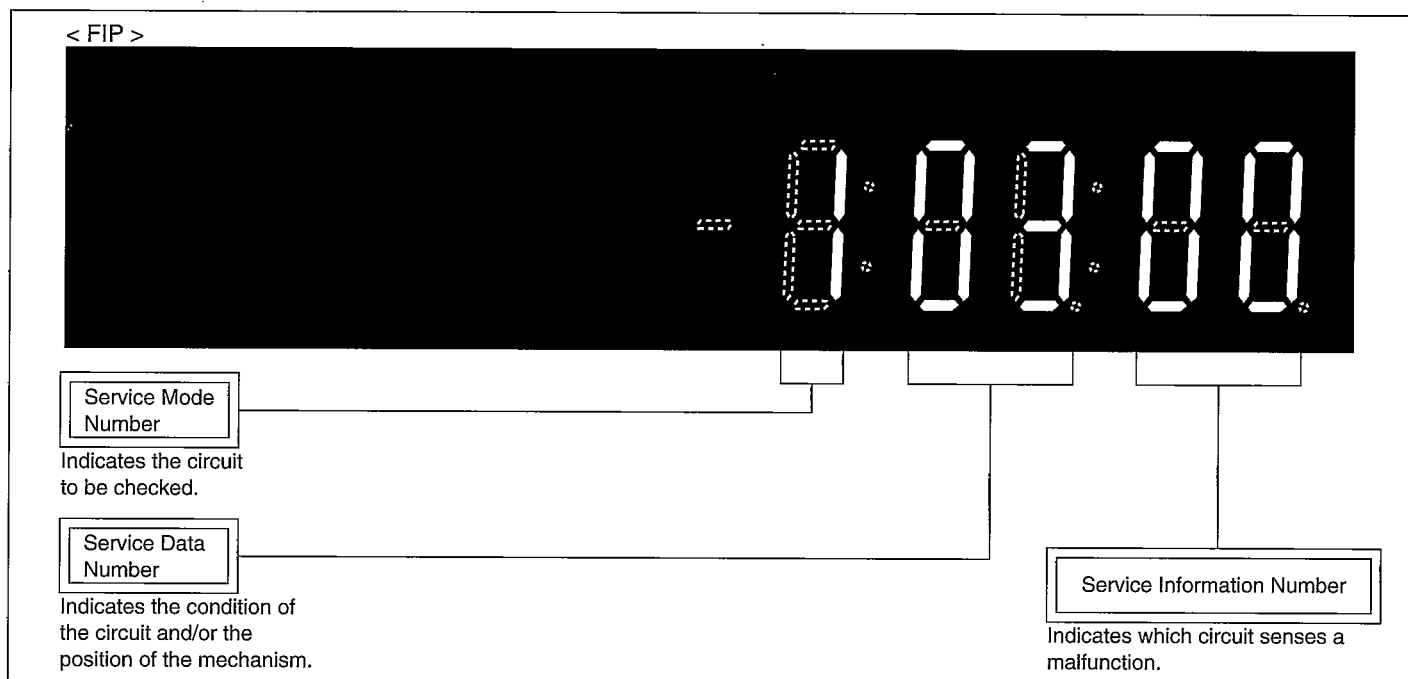

Fig. D1 Service Information Display

7-1. Purpose of Service Information Display

This information aids trouble shooting by indicating the source of the malfunction. The service mode number & service data number are used by the technician during repair while the service information can be used by consumer to diagnose malfunctions allowing the technician to provide a more accurate repair cost estimate and reduce repair time.

7-2. Turning on Service Information Display

Press FF and EJECT buttons simultaneously for more than 3 seconds. In case of VCR mounted shuttle ring, turn the shuttle ring to FF and then press EJECT button for more than 3 seconds.

In Loewe model, STOP button is used instead of FF button.

In the Service Information Display, there are four digits divided into 3 functions.

The first digit indicates which of the 7 service modes that the unit is currently in.

MODE 1: Checks tape protection circuit.

MODE 2: Checks tape transport mechanism.

MODE 3: Checks mode switching operation.

MODE 4: Checks control buttons.

MODE 5: Checks capstan motor.

MODE 6: Checks cylinder motor.

MODE 7: Checks loading/unloading operation.

The second and third digits are service data which indicate the condition of the circuit or mechanism being checked.

The fourth digit is the service information display. it is to be used by the consumer to help determine the source of a malfunction. The service information display operates independently of the service modes and stores the fault indication in memory for as long as AC power is not supplied.

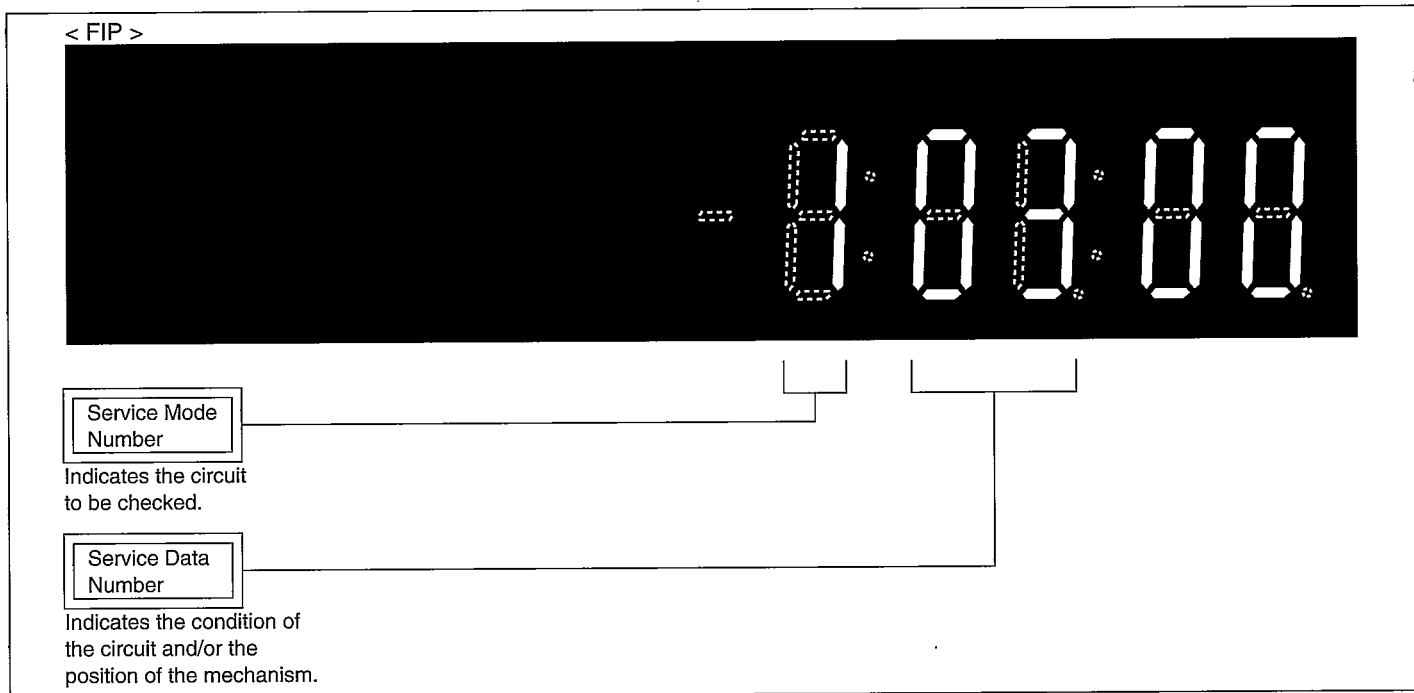

Fig. D2 Service Mode Number and Service Data Number on F.I.P.

7-3. Use of Service Modes

- (1) Turn on Service information Display.
- (2) To change Service Modes, press FF and EJECT buttons simultaneously.
- (3) Mode 0: Storing the process number when the fault happened.
- (4) Mode 1: Checks that the sensor LED, Supply & Take-up sensor circuits checks the circuits by blocking the light from the sensor LED to either or both Supply & Take-up Sensors. When the light is blocked to both sensors, "00" should be indicated on the service data number.
When the light is blocked to the supply sensor, "01" should be indicated.
- (5) Mode 2: Checks the mode switch circuit while indicating mechanism position. Service Data Numbers indicate the position of the mode switch and there by the mechanism position.
- (6) Mode 3: Checks that mode switch circuit operations have been completed. Service Data Number should indicate "00" after each mechanism operation is completed.

(7) Mode 4: Checks the operation circuit.

Indicates if SYSTEM CONTROL IC receives the operating commands from the mode buttons and/or remote controller.

(8) Mode 5: Checks the capstan motor circuit.

Indicates if the SYSTEM CONTROL IC has received the command to rotate the capstan motor.

(9) Mode 6: Checks the cylinder motor circuit.

SYSTEM CONTROL IC has received the command to rotate the cylinder motor.

(10) Mode 7: Checks the loading/unloading operation.

The loading motor rotates for loading operation when the "PLAY" button is pressed.

The loading motor rotates for unloading operation when the "STOP" button is pressed.

This mode can be displayed indefinitely until the OPERATE button is pressed.

<NOTE> Refer to Fig. D5 for details of Service Data Numbers.

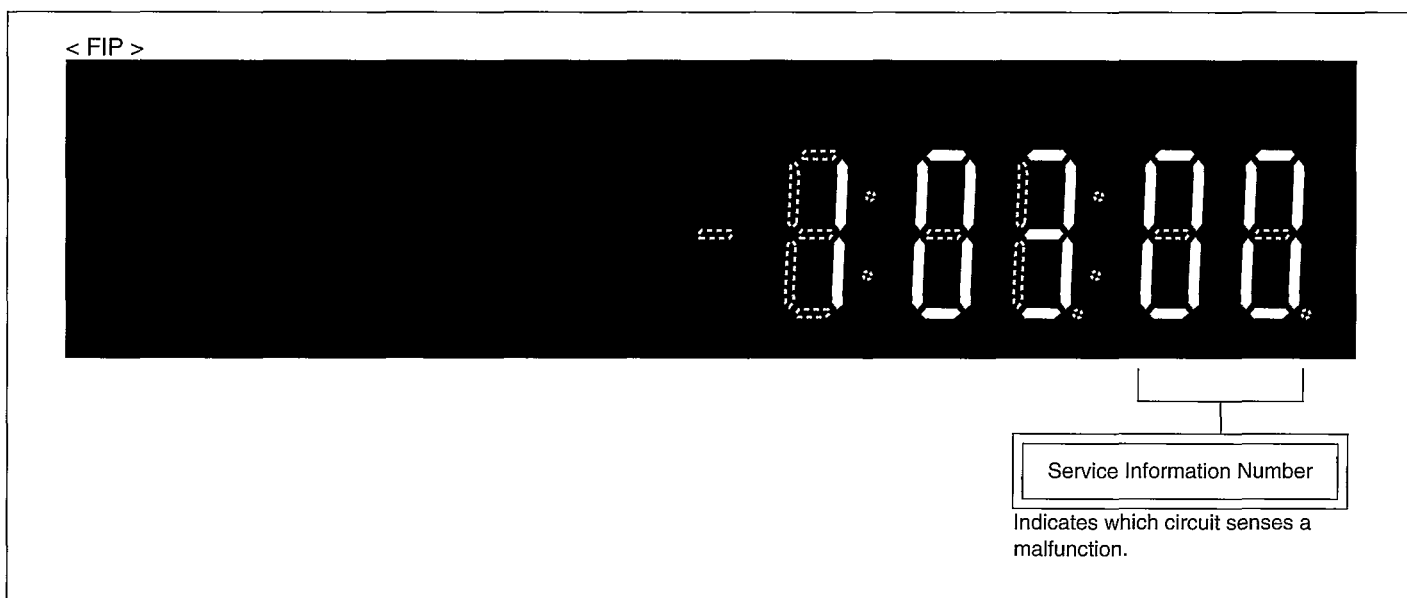

Fig. D3 Service Information Number on F.I.P.

7-4. Service Information Number

Refer to Fig. D4 for details of Service Information Number.

NOTE: The Service Information Number display is independent of the service mode display. The Service Information Number will be stored as long as AC power is not supplied. (It can be displayed in the Service Mode 2.)

If a second error occurs, only the most recent error will be displayed.

Service Information Number	Malfunction
00	Normal condition (No problem)
10	Dew formation
01	Cylinder stop
02	Tape reel stop
03	Stop at position other than 04 or 06
04	Stop during unloading
06	Stop during Cassette-in/Eject operation
07	Recording circuit stop in recording mode.
08	Recording circuit stop except recording mode.
16	Cylinder lock
17	Supply reel lock
18	Take-up reel lock
2*	PG shifter automatic adjustment error

Fig. D4 Detail Service Information Number

7-5. Test Mode

When the test terminals are shorted during turning off condition, the following operation will be performed after AC power is applied. Test Mode Information will be displayed on FIP instead of linear counter. To release Test mode, test Terminals should be opened.

- (1) Power will be turned on automatically when AC power is applied.
- (2) The direct operation of buttons are able to be performed.
(Example) PLAY \longleftrightarrow REC, REC \rightarrow EJECT, REC \rightarrow FF/REW
- (3) In case the mechanism is in PLAY position, the mechanism goes into PLAY mode when AC power is applied.
- (4) Playback CVC function is turned off.
- (5) Tracking is fixed under power off and cassette in. Auto tracking does not perform.
- (6) For recording current adjustment.
- (7) For reverse slow tracking adjustment.
- (8) When the power is turned off, tracking is fixed.

Service Mode Number	Note for checking Service Data Numbers	Service Data Numbers	Indication	Remarks
1	—	00	No light detected at either sensor	Tape not required.
		01	Tape beginning Light to Supply photo sensor is blocked.	
		02	Tape end Light to Take-up photo sensor is blocked.	
		03	Light detected at both sensors.	
2	—	00	EJECT	Tape required *1. STOP3: Pinch roller is on Capstan motor shaft. *2. STOP: Pinch roller is off Capstan motor shaft.
		01	Cassette down	
		02	REV, REV SLOW	
		03	Loading/Unloading	
		04	PLAY, REC, STILL, PAUSE, CUE, FWD SLOW, STOP3*1	
		05	STOP*2	
		06	FF/REW	
3	Disregard service data displayed until mechanism operation is completed. Then the display should indicate "00".	00	Any display other than "00" indicates a fault in the mode switch circuit or system.	Tape required.
4	Display only when the operating button is pressed.			Tape not required.
5	Left digit only, disregard Right digit display.	8 1 Left Right Digit Digit	8, 9, u, A, —, n, L and no display indicate that the Capstan motor "PLAY" command received by System control microprocessor.	Tape required. If a symbol other than those listed is displayed, a malfunction in that circuit is indicated.
	Right digit only, disregard left digit display.	8 7 Left Right Digit Digit	1, 2, 3, 4, 5, 6, 7 indicate that the Capstan motor "CUE, FF, FWD SLOW" commands received by system control microprocessor.	
	Right digit only, disregard left digit display.	8 — Left Right Digit Digit	8, 9, u, A, —, n, L and no display indicate that the Capstan motor "Reverse, REW, Reverse Slow" commands received by system control microprocessor.	
6	Left digit only, disregard Right digit display.	1 0 Left Right Digit Digit	1, 3, 5, 7, 9, A, n and no display indicate that the cylinder motor "ON" command received by system control microprocessor.	Tape required. If a symbol other than those listed is displayed, a malfunction in that circuit is indicated.

Fig. D5 Service Data Display and Indication

7-6. Timing chart from Mode SW to System control IC

System control IC senses the mechanical position through the Mode SW.

Fig. D6 shows the timing for service mode number 2.

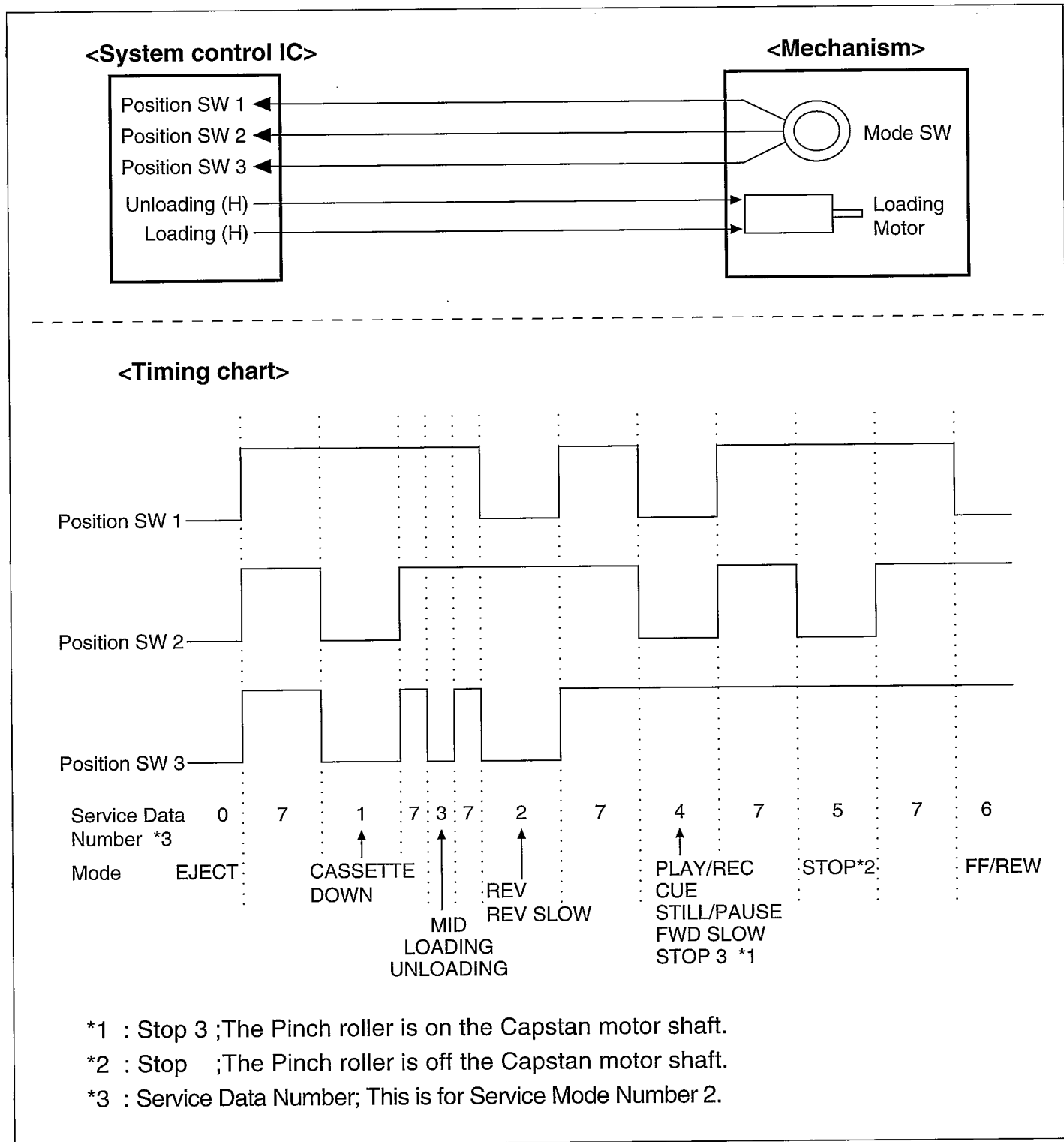

Fig. D6 Timing chart of Mode SW

8. SYSTEM CONTROL CIRCUIT & MECHANISM CONTROL CIRCUIT

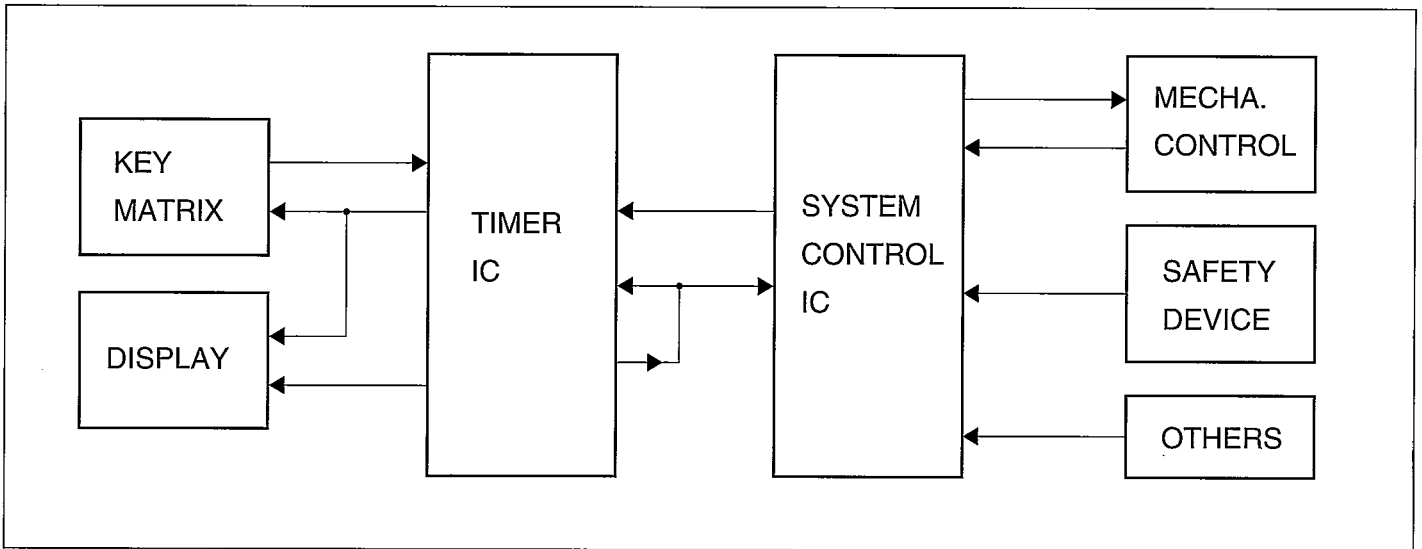

Fig. S1 Overall Block Diagram of System Control Circuit

8-1. STOP3 Specification

- (1) The STOP3 is the playback stand-by mode.
- (2) The unit is put into the STOP3 position after tape loading if the cassette tape does not have a clear leader tape.
- (3) If the unit is in the STOP3 position when the power is switched off (included the Timer stand-by mode), the unit goes to the STOP position.
- (4) If the cassette is in the unit when the power is turned on, the unit goes to the STOP3 position.
- (5) When the cassette tape has clear leader tape, the unit is in loading mode after winding up the clear leader tape by Take-up reel at the cassette down position and the unit goes to STOP3 position.

8-2. Stand-by in the STOP3 position

- (1) The unit goes to STOP3 position when the Stop mode is selected during the Play or Rec operations. The unit then loosens the tape tension by performing the Reverse Slow. The Reverse Slow corresponds to the FG 40 pulses of the capstan (irrespective of SP/LP modes). The cylinder continues to rotate.
- (2) After about 5 minutes in STOP3 mode, the unit shifts to the Stop position and then the unit stops the cylinder rotation.

8-3. Supply and Take-up Sensors

Supply and Take-up photo transistors are used to sense the beginning and end of a tape. The tape has transparent leaders at the beginning and end.

When these transparent leaders enter the tape transport path, they allow infrared light from the sensor LED to reach either one of the tape end sensors (photo-transistor).

If the Take-up end sensor detects the light, the microprocessor SYSTEM CONTROL IC places the VCR in the Stop mode and then performs a short Cue.

If the Supply end sensor is triggered, the microprocessor activates the Stop mode and the Rewind mode. The Rewind mode continues until the Take-up end sensor detects the end of the tape. The tape beginning is detected by a low signal at SYSTEM CONTROL IC Take-up photo terminal. The tape end is detected by a low signal at SYSTEM CONTROL IC Supply photo terminal.

If the light is received at both sensors at same time, the cassette is ejected.

<Operation after detecting the beginning and the end of tape>

Mode	Detection of the beginning	Detection of the end
Power off→on	Short CUE	Short REW
Cassette in	Short CUE	Short REW
Loading	Short CUE	Short REW
FF/CUE	—	Auto REW
REW/REV	Short CUE	—
PLAY, REC	—	Auto REW
Timer REC	—	Power off

Both ends of tape detection (tape cut, no cassette),

- (1) Cassette in: The cassette tape is ejected
- (2) Other mode: The unit goes to Stop mode and it is impossible to operate except EJECT key.
- (3) Timer REC: Power is turned off after short CUE is performed.

8-4. Safety Tab Switch

A recorded video cassette can be protected against accidental erasure by breaking off the tab on the cassette. The cassette can now only be used for playback. To be able to record on the cassette, cover the hole with adhesive tape. If the safety tab on the cassette has been removed, Safety Tab Switch is off (open) and high signal is supplied to SYSTEM CONTROL IC Safety Tab terminal. The SYSTEM CONTROL IC will not go into the recording mode and automatically places the VCR in the playback mode.

8-5. Dew Sensor

If excessive moisture or condensation is present inside the machine (an internal humidity of more than 98%) the unit will stop if running. Until the moisture level decreases only the Eject mode will operate. To sense the humidity, a dew sensor is used. The sensor is a special variable resistor which change resistance with ambient humidity.

The sensor ranges in resistance from about 5K ohm at 90% humidity to about 50K omh at 98% humidity. Normally, the voltage across the sensor is low because of its low resistance.

But if moisture condenses inside the unit, the SYSTEM CONTROL IC voltage of Dew terminal increases to indicate a Dew condition.

Tape	Mode	Dew sensor ON	Dew sensor OFF
OUT	Power	Compulsory Power on	Power off
	Dew indication	Indicate "d" and "U10"	Normal indication
	Cylinder	Rotating *1	Stop
	Key operation	Not possible *2	Possible
	Cassette in	Immediately a cassette is ejected after it goes to cassette down position.	Possible
IN	Power	Compulsory Power on	Power off
	Dew indication	Indication "d" and "U10"	Normal indication
	Cylinder	Rotating *1	Stop
	Key operation	Not possible *2	Possible
	Cassette condition	A cassette goes to down position and is in stand-by mode.	Stand-by mode at STOP3 position.

*1: When the cylinder locks in dew mode, it will be released until dew sensor is truned off.

*2: The keys which do not relate to the tape running operation, are able to be used.

Dew sensor on: During Dew formation is detected and 80 minutes after completion of Dew detection.

Dew sensor off: 80 minutes later after copmletion of Dew detection.

8-6. Setting time for each mode

The time is set on each mode in order to protect tape and capstan driver. When the setting time is over, the mode is gone to the next mode.

Mode	Setting time	Switching mode
STILL, PAUSE	Approximately 5 minutes	STOP
CUE/REV lock	Approximately 10 minutes	PLAY
SLOW	Approximately 10 minutes	STOP

8-7. Operation of short CUE

Short CUE stops when the Take-up photo sensor detects the black portion of the tape.

However its sensor does not detect the black portion within 4.0 ± 1.0 sec., the mode except Power on/off and Eject modes will be able to be operated after the unit stops. This is same as the timer over operation of the reel lock.

8-8. Loading/Unloading Mechanism lock

Loading and unloading times are set, and in case the mechanism locks during loading or unloading operation within the defined time, the unit detects the mechanism lock and loading motor reverses or stops.

Loading operation lock: Cassette tape is unloaded and ejected within 5 seconds.

Unloading operation lock: Power is turned off within 5 seconds.

8-9. Cassette loading/unloading lock

(1) Mechanism locks during the cassette in operation.

- ① Cassette tape is ejected approximately 2 seconds later when the mechanism locks during the cassette in operation.
- ② In case mechanism locks during eject operation, cassette tape is inserted and power is turned off approximately 2 seconds later.
- ③ When Mechanism locks during cassette in operation, power is turned off approximately 2 seconds.

In case the mechanism lock is released on the way and cassette is ejected, the unit continues the normal operation.

(2) Mechanism locks during the eject operation.

- ① Cassette tape goes to cassette down position approximately 2 seconds later and power is turned off when mechanism locks during eject operation.
- ② Mechanism locks during cassette down operation, power is turned off.

8-10. Reel lock operation

When the Supply or Take-up reel mechanism locks during the tape running, the following operation is performed in order to protect the tape and the capstan driver.

In case of Take-up reel mechanism lock, the detecting time is defined depending on the mechanism position and capstan speed to minimize the tape supplying from supply side.

FF/REW : Unloading and loading. The unit goes to CUE/REV mode.

PLAY/CUE/REV : Unloading till the cassette down position and loading. The unit goes to STOP3 position.

In play and CUE/REV mode, the reel pulse cycle is started to count after the mechanism mode is fixed.

In case the counted pulse cycle exceeds the defined value, the unit goes to STOP mode due to judge that lock of reel mechanism is detected.

<The value of reel lock detection time>

NTSC/SP mode

Mode	Speed (Ratio)	Time (S)
PLAY	±1	3.5
CUE/REV	±2.5	1.6

PAL/SP mode

Mode	Speed (Ratio)	Time (S)
PLAY	±1	3.5
CUE/REV	±2.5	1.6

In FF/REW mode, the unit goes to CUE/REV mode and continues the tape running in the following case.

- (1) Take-up reel pulse can not be detected within 5 seconds after the unit shifted to REW mode.
(2) Supply reel pulse can not be detected within 5 seconds after the unit shifted to FF mode.
- The reel pulse can not be detected more than 2 seconds sequentially within 5 seconds after completing the mechanism mode shift.
- The reel pulse can not be detected more than 800 msec. past 5 seconds after completing the mechanism mode shift.

8-11. Cylinder lock

<Start rotation>

When the cylinder neither start rotating nor go to the stability rotation within 5 seconds, it is unloading under keeping the mode. In case the cylinder starts rotating and goes to the stability rotation, the mechanism loads again and continues the holding mode.

If it is not possible, Power is turned off and cylinder trouble "H01" is displayed.

<During rotation>

The head switching pulse is supplied to the cylinder when the cylinder starts the stable revolution. In case the head switching pulse does not come to the cylinder within 0.5 seconds, the cylinder lock is judged and the following operation is activated.

Timer REC mode: Power off

PLAY, REC mode: STOP (Mechanism shifts to MID. position and the unit goes to stand-by mode.)

8-12. Mode transition

The relation between the present mode and operation key is shown in the following table.

PRESET MODE	OPERATION KEY							
	P SW	EJECT	STOP	REW	FF	PLAY	PAUSE	REC
P-OFF	P-ON	EJECT	—	—	—	PLAY	—	—
EJECT	P-OFF	—	—	—	—	—	—	—
STOP	P-OFF	EJECT	*3	REW	FF	PLAY	—	REC
REW	P-OFF	EJECT	STOP	REV	FF	PLAY	—	—
FF	P-OFF	EJECT	STOP	REW	CUE	PLAY	—	—
REV	P-OFF	EJECT	STOP	—	*1	PLAY	*2	—
CUE	P-OFF	EJECT	STOP	*1	—	PLAY	*2	—
PLAY	P-OFF	EJECT	STOP	*1	*1	—	*2	—
STILL	P-OFF	EJECT	STOP	*1	*1	PLAY	PLAY	REC PS
REC	P-OFF	—	STOP	—	—	—	REC PS	—
REC/PS	P-OFF	—	STOP	—	—	—	REC	REC

Pressing two keys simultaneously, the key operation is going to be ineffective.

*1: The unit goes to CUE/REV lock mode by pressing FF/REW key lightly (less than 0.7 seconds) during Play, still and REV mode. CUE/REV mode will be returned previous mode when FF/REW key is pressed more than 0.7 seconds.

*2: In case PAUSE key is pressed less than 1 second other than STILL mode, the unit goes to STILL mode.

If PAUSE key is being held to press, the unit goes to STILL mode and then goes to 1/10 SLOW mode after 1 second. SLOW mode has not been set in 2 Head LP mode model.

*3: When STOP key is pressed more than 3 seconds while a cassette tape is in the unit, the cassette tape is ejected.

8-13. Power on reset

When the power is turned on, the unit is going to reset and the following datas are cleared.

- (1) Position switch data
- (2) Operation mode data
- (3) Prohibition flags

In case the mechanism is in cassette down position, tape slack is removed as the initial operation and the unit goes to STOP3 position.

8-14. Linear time counter operation

The counter value will be gone up/down by counting control pulse. As for NTSC system during Play/Rec mode, counter value goes up/down every 30 pulses. As for PAL system during Play/Rec mode, counter value goes up/down every 25 pulses.

8-15. Tape speed in CUE/REV mode

MODE	CUE/REV mode		Hyper-search mode	
	NTSC	PAL	NTSC	PAL
SP mode	9 times	11 times	9 times	11 times
EP or LP mode	11 times	11 times	29 times	19 times

8-16. Automatic functions

(1) Automatic Power on

- ① Under power off, when a cassette tape is inserted, power is turned on automatically and cassette tape is loaded.
- ② Under power off and a cassette tape has been inserted, when PLAY key is pressed, power is turned on automatically and goes to PLAY mode.

(2) Automatic play

When a cassette tape removed safety tab is inserted, the mode goes into Play mode.

(3) Automatic rewind

When tape running is reached to the end of tape, automatically goes to Rew mode and stops when tape running will be reached to the beginning of tape.

In case of Timer recording, short Rew is performed for 2 seconds and power is turned off when tape running is reached to the end of tape.

(4) Power off and Eject

Under power off and a cassette tape has been inserted, when Eject key is pressed, a cassette tape is ejected and power is turned off.

8-17. CUE/REV lock mode

When FF/REW key is pressed lightly (less than 0.7 seconds) during Play, STILL and REV mode, unit goes into CUE/REV mode. To release CUE/REV mode, FF/REW key should be pressed more than 0.7 seconds.

8-18. Hyper-search mode

When FF/REW key is pressed during FF/REW mode, unit goes into CUE/REV mode.

This mode is activated while keeping FF/REW key pressed.

When releasing FF/REW key pressed, this mode is released.

8-19. FF/REW speed

Maximum tape speed is approximately 4.5 m/s during the stable running.

8-20. FF/REW time

The tape running from the beginning to the end of T-120 type (E-180 type) cassette tape is able to be completed within 90 seconds.